

Catálogo2017
*Catalogue*2017

הנהלת

Índice *Index*

1. Introducción <i>Introduction</i>	2
2. Sistemas de iluminación lineal LED <i>LED linear lighting systems</i>	10
3. Perfiles <i>Profiles</i>	75
4. Luminarias <i>Lights</i>	113
5. Fuentes de alimentación <i>Power supplies</i>	119
6. Sistemas de control <i>Control systems</i>	125
7. Iluminación dinámica <i>Dynamic lighting</i>	145
8. Esquemas y recomendaciones <i>Schemes and recommendations</i>	178
9. Referencias y precios <i>References and prices</i>	183

Por qué Lluria? Why Lluria?

Somos especialistas en Tecnología LED Lineal y en proyectos a medida con Iluminación Dinámica y Diseño Paramétrico.

Esta especialización nos permite ofrecer el catálogo más amplio del sector y la mejor calidad en productos para que nuestros clientes personalicen y expresen con la luz todo aquello que han imaginado.

En 1985 el matrimonio formado por Josefa Egea y Joan Planellas, en un pequeño garaje de Mollet de Vallés en Barcelona, comienzan a fabricar luminarias decorativas con la idea de desarrollar una empresa de iluminación. Trabajaban con diseños propios y de manera artesanal, siendo **pioneros** en la introducción de las lámparas **halógenas** en sus luminarias.

Tras unos años de recorrido y evolución, en el año 2000, uno de los hijos de los propietarios, Toni Planellas, toma las riendas y decide dar un giro al negocio apostando por la, en ese momento, incipiente **tecnología LED**.

La empresa continúa creciendo durante esa década, pero sin alejarse nunca del **espíritu humano y familiar** de su origen, ni de la

inquietud de evolucionar y ofrecer siempre el mejor producto y tecnología posibles.

En el 2014, nuevos retos hacen que Lluria dé otro salto como empresa al enfocar conocimiento y producto hacia el desarrollo de **grandes proyectos de iluminación dinámica** y hacia la **personalización** de su tecnología LED para cada proyecto, diseñador y/o cliente.

Convirtiendo a Lluria en la empresa de referencia del sector que es hoy.

Nuestra fábrica actual está situada en Martolleres (Barcelona) y es el corazón de la empresa, junto con nuestro equipo humano que hace posible esta continua evolución hacia proyectos cada vez más ambiciosos e internacionales.

We are specialists in Linear LED Technology and in custom projects with Dynamic Lighting and Parametric Design.

This specialization allows us to offer the most extensive catalog of the sector and the best quality in products for our customers to personalize and express with light everything they have imagined.

In 1985 the marriage formed by Josefa Egea and Joan Planellas, in a small garage of Mollet de Vallés in Barcelona, begin to manufacture decorative luminaires with the idea of developing a lighting company. They worked with their own designs and craft, being **pioneers** in the introduction of **halogen lamps** in their luminaires.

After a few years of travel and evolution, in 2000, one of the owners' sons, Toni Planellas, took the reins and decided to turn the business around by betting on the incipient **LED technology**.

The company continues to grow during this decade, but never depart from the **human and family spirit** of its origin, and no restlessness to develop and always offer the best product and technology possible.

In 2014, new challenges make Lluria take another leap as a company by focusing knowledge and product to the development of **large dynamic lighting projects** and to the **customization** of its LED technology for each project, designer and/or client.

Turning Lluria into the reference company of the sector that it is today.

Our current factory is located in Martolleres (Barcelona) and is the heart of the company, together with our human team that makes possible this continuous evolution to increasingly ambitious and international projects.

LLURIA

Proyectos Projects

Gracias a la **Iluminación Dinámica** y su faceta más creativa; al **Diseño Paramétrico** que nos ofrece maneras de estructurar la iluminación; y a su gran versatilidad al trabajarlos conjuntamente, en Lluria conseguimos desarrollar cualquier proyecto que se nos plantee, consiguiendo resultados espectaculares.

Para ello, desde el **Departamento de Proyectos** nos encargamos de ofrecer soluciones a medida **personalizando** y ayudando a plasmar las ideas y retos de nuestros clientes mediante nuevas soluciones prácticas y reales, y acompañándolos durante todo el proceso.

Bajo nuestra inquietud de simplificar y cubrir cualquier demanda, también hemos diseñado una **gama de control** propia para la iluminación dinámica -**Lightbox**- con la que el diseñador solo tiene que elegir la luz sin pensar en el control.

También estamos especializados en **luminarias realizadas a partir del Diseño Paramétrico**, que desarrollamos a medida con esta tecnología. Así hemos creado soluciones como nuestras **Waves y Blocks**.

Thanks to **Dynamic Lighting** and its more creative facet, the **Parametric Design**, that offers us ways to structure the lighting; And their great versatility to work together, in Lluria we manage to develop any project that we consider, achieving spectacular results.

For this, from the **Project Department** we take care of offering tailor-made solutions **customizing** and helping to capture the ideas and challenges of our customers through new practical and real solutions, and joining them throughout the process.

Under our concern to simplify and cover any demand, we have also designed a range of own **control for dynamic** lighting -**Lightbox**- with which the designer only has to choose light without thinking about the control.

We are also specialized in **luminaires made from Parametric Design**, which we tailor made with this technology. Thus, we have created solutions like our **Waves and Blocks**.

Centro Comercial Ganjlik Mall
Baku (Azerbaijan)
LDC / inSense



Fachada Avinyó
Barcelona
DLLUM BCN

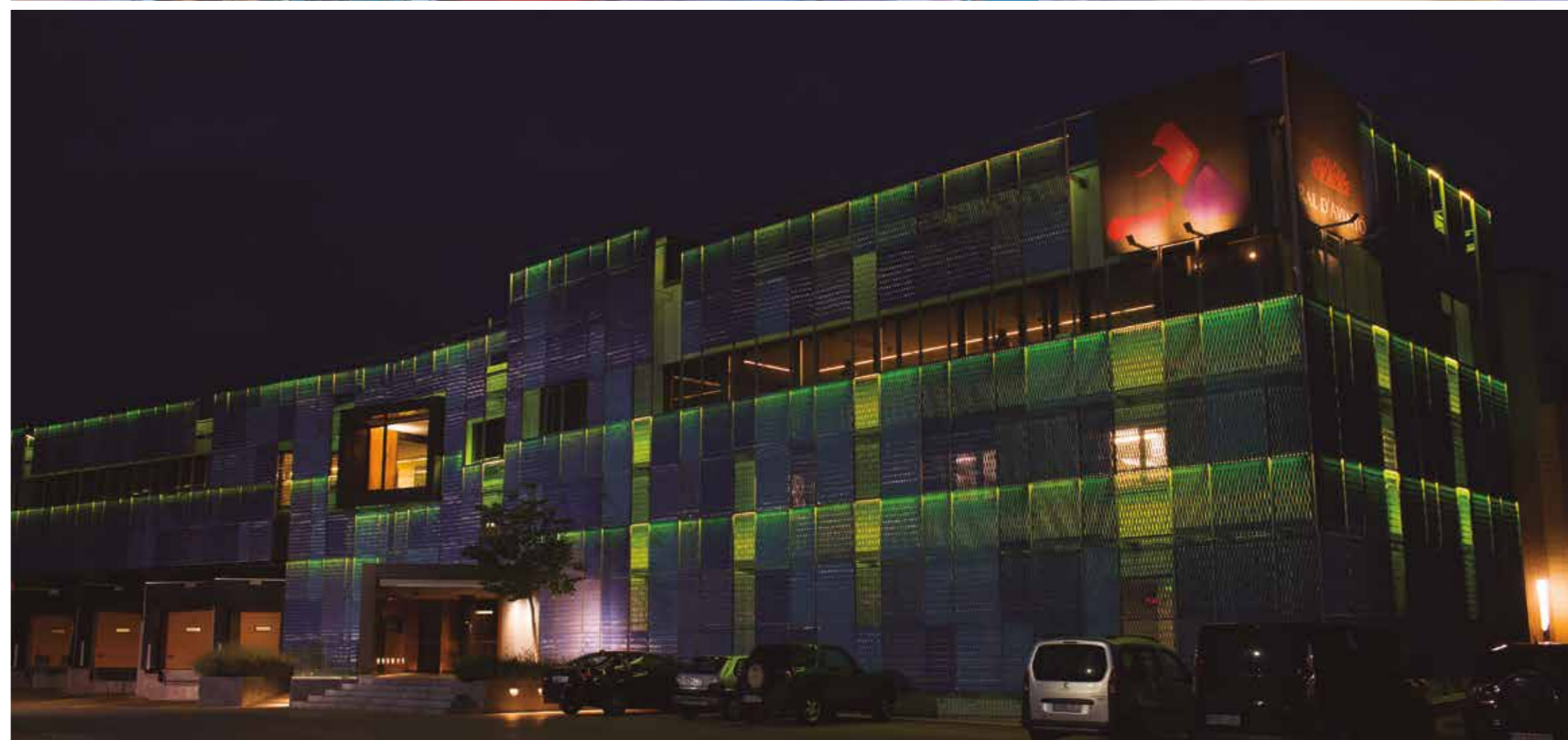

I+D+i
R&D+i

Analizamos y aplicamos las últimas tecnologías para mejorar los procesos con la intención de ofrecer la máxima calidad de producto y desarrollar proyectos cada vez más eficientes y creativos. Para ello es necesaria una continua **investigación** que permita a nuestros ingenieros y diseñadores **innovar** en el **desarrollo** de nuevos productos y sistemas.

El **análisis** es la clave para buscar la excelencia en los sistemas de iluminación; optimizando todos sus valores.

Y la **innovación** la llevamos un paso más allá apostando también por talentos externos que nos ayudan a mejorar el diseño de nuevos productos.

We analyze and apply the latest technologies to improve the processes with the intention of offering the highest quality of product and **develop** projects increasingly efficient and creative. This requires continuous **research** that allows our engineers and designers to **innovate** in the development of new products and systems.

Analysis is the key to finding excellence in lighting systems; Optimizing all its values.

And the **innovation** we take a step further betting also by external talents that help us to improve the design of new products.

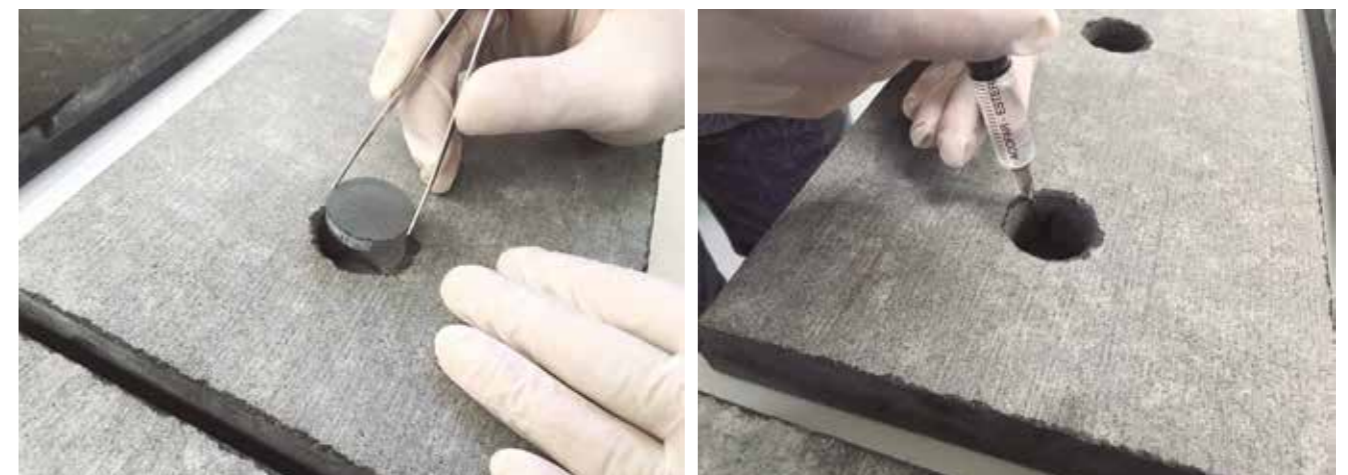

Calidad Quality

Sallés Hotel & Spa Mas Tapiolas
Girona
Espais Dil·luminació

Creemos firmemente que si Lluria se ha convertido en una empresa de referencia en el sector es gracias a nuestra preocupación por la calidad de los productos.

En el **Departamento de Calidad** revisamos las diferentes fases del desarrollo de los productos, verificamos los estándares de calidad y comprobamos todas las certificaciones internacionales -CE, UL, TUV, Rohs-, **ofreciendo garantías de entre 3 a 7 años.**

Temperatura de color (CCT)
Nuestro nivel de exigencia, nos ha llevado a

realizar una mejora continua de nuestro proceso de producción que nos permite ofrecer a nuestros clientes un CCT muy uniforme, obteniendo 3 pasos MacAdam.

Índice de Reproducción Cromática (IRC) y Rendimiento Lumínico (Lm/W)

Superamos un IRC del 95 en algunas de nuestras gamas y los 150 Lm/W.

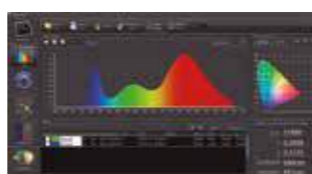

We firmly believe that if Lluria has become a reference company in the sector it is thanks to our concern for the quality of the products.

In the **Quality Department**, we review the different phases of product development, check the quality standards and check all the international certifications - CE, UL, TUV, Rohs -, **offering guarantees between 3 and 7 years.**

Color temperature (CCT)
Our level of exigency, has led us to make a

continuous improvement of our production process that allows us to offer our customers a very uniform CCT, obtaining 3 steps MacAdam.

Chromatic Reproduction Rate (CRI) and Light Efficiency (Lm/W)

We overcome 95 CRI in some of our ranges and 150 Lm/W.

Servicio y atención al cliente Customer service

Cada cliente y proyecto tiene unas necesidades específicas que necesitan un servicio y atención diferente durante todo el proceso. Para ello mantenemos una comunicación continua con el cliente, damos **asesoramiento previo, soporte** durante los montajes y ofrecemos un **servicio postventa** para cubrir cualquier necesidad de mantenimiento o manejo del producto.

Each client and project has specific needs that require different service and attention throughout the process. For this we maintain a continuous communication with the customer, we give **previous advice, support** during the assembly and we offer a **after sales service** to cover any need for maintenance or handling of the product.

Encuentranos en Find us in



Conceptos Concepts

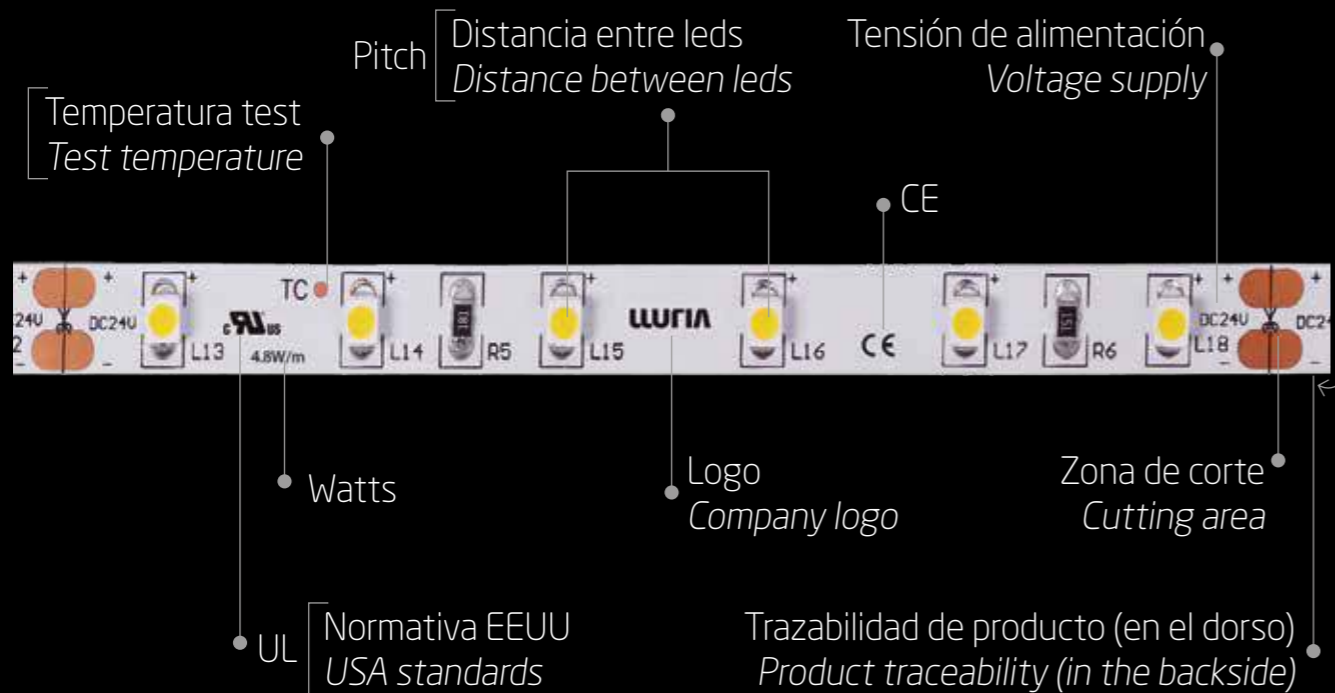

Descripción referencias Reference description

MON - 14,2 - 27 - 24
 TTN - 14,2 - RGB - 24
 TTN - 19,2 - R-A-27-55 - 24

Modelo / Model
 Watts
 CCT / Color
 Voltage / Voltage

A / AB - Ambar Amber
 AZ - Azul Blue
 RJ / R - Rojo Red
 UV - Ultravioleta Ultraviolet
 VD - Verde Green
 RGB - Rojo, verde, azul
 Red, green, blue
 RGBW - Rojo, verde, azul, blanco
 Red, green, blue, white

Blancos Whites
 23 = 2300k 40 = 4000k
 27 = 2700k 55 = 5500k
 30 = 3000k 60 = 6000k

Sistemas de iluminación lineal LED LED Linear Lighting Systems

Inside IP20

Energy 150 lm/w	13
Ariel CRI>95	15
Moon CRI>80	17
Titan Multi color - Multi CCT	22
Snake Adaptable a formas / Adaptable to shapes	25
Mini-LED Ancho 4mm / Width 4mm	27
Side Iluminación lateral / Side lighting	28
Basic	29
Accesorios Accessories	33

Protect IP54

Comet CRI>80	39
Halley Multi color - Multi CCT	42
Basic IP54	44
Accesorios Accessories	47

Waterproof IP67

Energy IP67 150 lm/w	51
Luxel CRI>80 y Multi color	53
Accesorios Accessories	58

Underwater IP68

Wolf Flex + IK08	63
Resiled Resinado / Resin	66
Accesorios Accessories	67

Gourmet

Pink Carne / Meat	71
Gold Panadería / Bakery and pastry	71
Deli Cocinados / Pre-cooked food	72
Fresh Frutas y verduras / Fruits and vegetables	72

Inside IP20

Sistema de Iluminación Lineal LED Flexible para uso interior. Amplia gama de potencias, temperaturas, colores, reproducciones cromáticas y eficiencias energéticas.

Flexible LED Line Lighting System for indoor use. Wide range of powers, temperatures, colors, color reproductions and energy efficiencies.



Energy 150 lm/w	13
Ariel CRI>95	15
Moon CRI>80	17
Titan Multi color - Multi CCT	22
Snake Adaptable a formas / Adaptable to shapes	25
Mini-LED Ancho 4mm / Width 4mm	27
Side Iluminación lateral / Side lighting	28
Basic	29
Accesorios Accessories	33

Energy

De alta intensidad lumínica y excelente uniformidad. Se trata de un sistema de máxima eficiencia energética con un rendimiento de 150 lm/w. Garantía de 5 años.

High luminous intensity and excellent uniformity. It is a system of maximum energy efficiency with a yield of 150 lm/w. 5 year warranty.

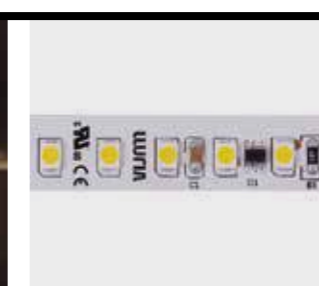

EN-20

Energy

5 Años Garantía	20 W/m	Necesita Disipador	55,5 mm
150 lm/w	126 LED/m	LED SMD 2835	R9 > 10
CRI > 80	24V	3 Pasos mcAdams	

EN-20-27-24	2700K	2800 lm/m
EN-20-40-24	4000K	3025 lm/m
EN-20-60-24	6000K	3150 lm/m

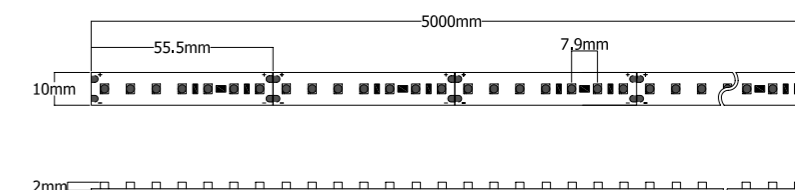

62,67 € 282,00 €

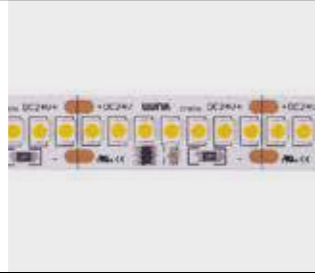

EN-37

Energy

- 5 Años Garantía
- 37 W/m
- Necesita Disipador
- 29,5mm
- 150 lm/w
- 238 LED/m
- LED SMD 2835
- R9 > 10
- CRI > 80
- 24V
- 3 Pasos mcAdams

EN-37-27-24	2700K	5285 lm/m
EN-37-40-24	4000K	5715 lm/m
EN-37-60-24	6000K	5950 lm/m

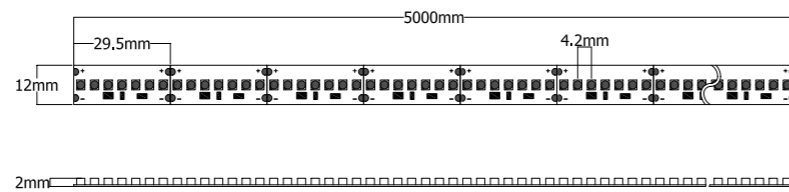

- PVP € x m
- PVP € x 5m
- 125,56 €
- 565,00 €

Teatre Romea
Barcelona
Noutres Productions
Xavier Valls

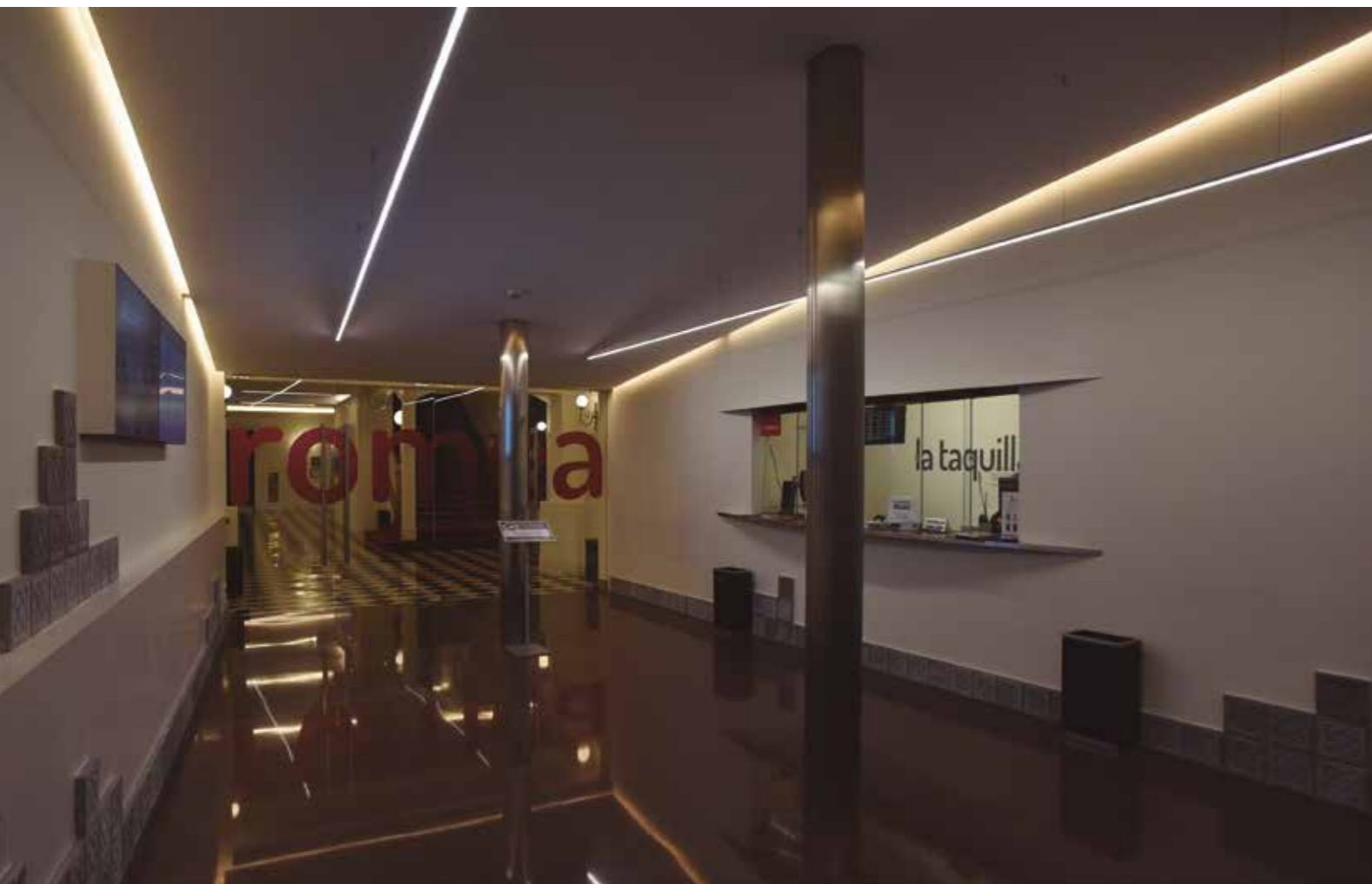

Ariel

Gamas cromáticas realistas. Máxima calidad para uso interior con un Índice de Reproducción Cromática (CRI) de 95. Garantía de 5 años. Realistic chromatic ranges. Maximum quality for indoor use with a Chromatic Reproduction Index (CRI) of 95. 5 year warranty.



- 5 Años garantía
- >95 CRI
- 3 Pasos mcAdams



ARI-14,2

Ariel

- 5 Años Garantía
- 14,2 W/m
- Necesita Disipador
- 100 mm
- 60 LED/m
- LED SMD 2835
- R9 > 25
- CRI > 95
- 24V
- 3 Pasos mcAdams

ARI-14,2-30-24	3000K	1580 lm/m
ARI-14,2-40-24	4000K	1645 lm/m

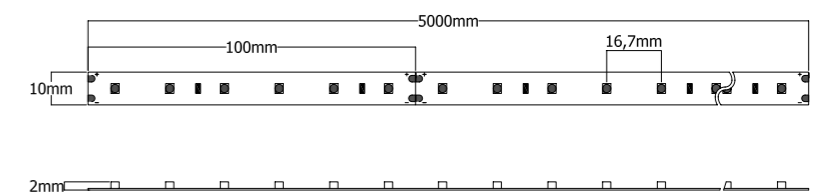

- PVP € x m
- PVP € x 5m
- 29,67 €
- 133,51 €

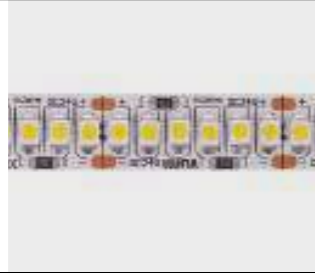

ARI-19,2

Ariel

- 5 Años Garantía
- 19,2 W/m
- Necesita Disipador
- 25 mm
- 240 LED/m
- LED SMD 3528
- R9 > 25
- CRI > 95
- 24V
- 3 Pasos mcAdams

ARI-19,2-30-24	○ 3000K	1735 lm/m
ARI-19,2-40-24	○ 4000K	1775 lm/m

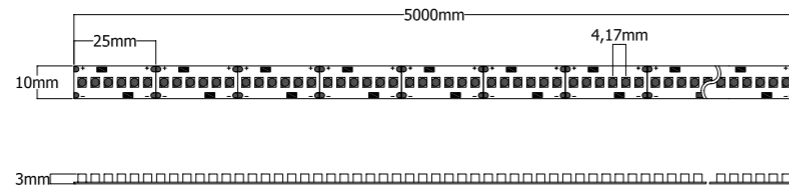

- PVP € x m
- PVP € x 5m

51,59 € 232,14 €

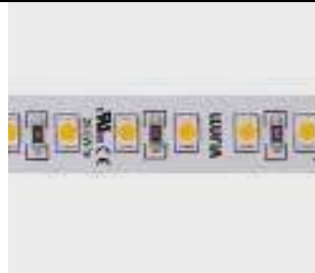

ARI-28,8

Ariel

- 5 Años Garantía
- 28,8 W/m
- Necesita Disipador
- 50 mm
- 120 LED/m
- LED SMD 2835
- R9 > 25
- CRI > 95
- 24V
- 3 Pasos mcAdams

ARI-28,8-30-24	○ 3000K	3290 lm/m
ARI-28,8-40-24	○ 4000K	3420 lm/m

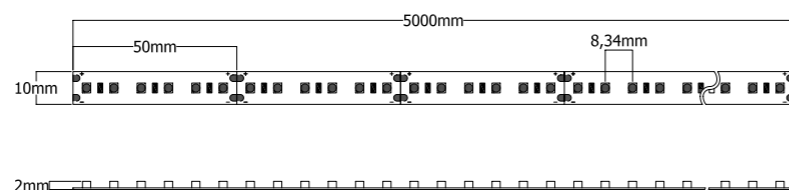

- PVP € x m
- PVP € x 5m

46,15 € 207,65 €

Moon

Gran variedad de potencias y colores para obtener un producto muy adaptable: señala, genera luz de acompañamiento y puede ser la máxima o única iluminación de una estancia. Con una Reproducción Cromática (CRI) superior a 80. Garantía de 5 años. Disponible en bobinas de 25 metros (potencias de 4,8, 9,6 y 14,2W/m).

Great variety of powers and colors to obtain a very adaptable product: it signals, generates light of back light and can be the maximum or only illumination of a room. With Chromatic Reproduction (CRI) up than 80. 5 year warranty. Available in 25 meter reels (power 4,8, 9,6 and 14,2W/m).



- 5 Años garantía
- >80 CRI
- 3 Pasos mcAdams



MON-4,8

Moon

- 5 Años Garantía
- 4,8 W/m
- 100 mm
- 60 LED/m
- LED SMD 3528
- CRI > 80
- 24V
- 3 Pasos mcAdams

MON-4,8-23-24	● 2300K	435 lm/m
MON-4,8-27-24	● 2700K	450 lm/m
MON-4,8-40-24	○ 4000K	470 lm/m
MON-4,8-55-24	○ 5500K	505 lm/m
MON-4,8-AB-24	● Ambar Amber	
MON-4,8-AZ-24	● Azul Blue	
MON-4,8-RJ-24	● Rojo Red	
MON-4,8-UV-24	● Ultravioleta Ultraviolet	
MON-4,8-VD-24	● Verde Green	

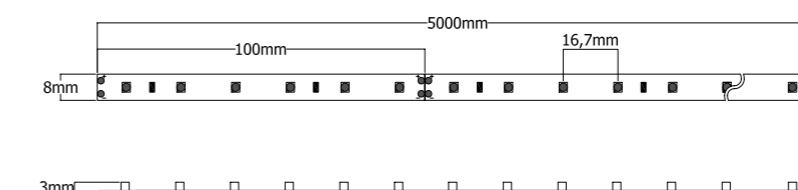

- PVP € x m
- PVP € x 5m
- PVP € x 25m

11,90 € 53,56 € 267,80 €



MON-9,6

Moon

5 Años Garantía

9,6 W/m

Necesita Disipador

50 mm

120 LED/m

LED SMD 3528

CRI > 80

24V

3 Pasos mcAdams

MON-9,6-23-24	● 2300K	865 lm/m
MON-9,6-27-24	● 2700K	895 lm/m
MON-9,6-40-24	○ 4000K	935 lm/m
MON-9,6-55-24	○ 5500K	1010 lm/m

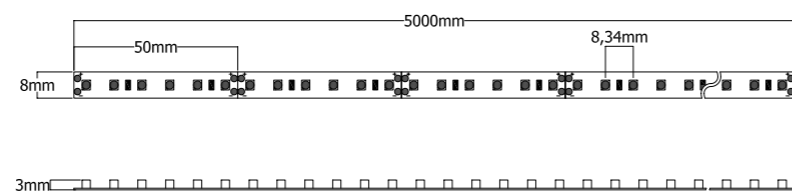

PVP € x m

PVP € x 5m

PVP € x 25m

21,42 € 96,41 € 482,04 €



MON-13,9

Moon

5 Años Garantía

13,9 W/m

Necesita Disipador

33,3 mm

180 LED/m

LED SMD 3528

CRI > 80

24V

3 Pasos mcAdams

MON-13,9-23-24	● 2300K	1300 lm/m
MON-13,9-27-24	● 2700K	1340 lm/m
MON-13,9-40-24	○ 4000K	1400 lm/m
MON-13,9-55-24	○ 5500K	1515 lm/m

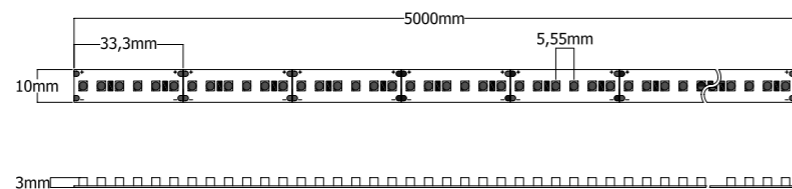

PVP € x m

PVP € x 5m

30,67 € 138,00 €



MON-14,2

Moon

5 Años Garantía

14,2 W/m

Necesita Disipador

100 mm

60 LED/m

LED SMD 2835

R9 > 10

CRI > 80

24V

3 Pasos mcAdams

MON-14,2-23-24	● 2300K	1500 lm/m
MON-14,2-27-24	● 2700K	1585 lm/m
MON-14,2-40-24	○ 4000K	1730 lm/m
MON-14,2-60-24	○ 6000K	1800 lm/m
MON-14,2-AB-24	● Ambar Amber	
MON-14,2-AZ-24	● Azul Blue	
MON-14,2-RJ-24	● Rojo Red	
MON-14,2-UV-24	● Ultravioleta Ultraviolet	
MON-14,2-VD-24	● Verde Green	

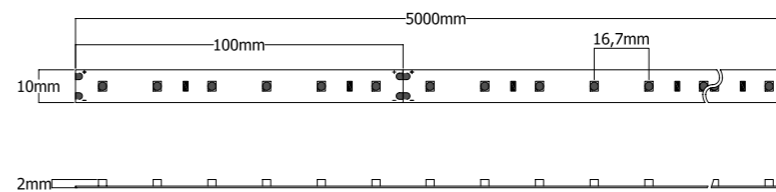

PVP € x m

PVP € x 5m

PVP € x 25m

23,83 € 107,24 € 536,22 €



MON-19,2

Moon

5 Años Garantía

19,2 W/m

Necesita Disipador

25 mm

240 LED/m

LED SMD 3528

CRI > 80

24V

3 Pasos mcAdams

MON-19,2-23-24	● 2300K	1730 lm/m
MON-19,2-27-24	● 2700K	1790 lm/m
MON-19,2-40-24	○ 4000K	1865 lm/m
MON-19,2-55-24	○ 5500K	2020 lm/m

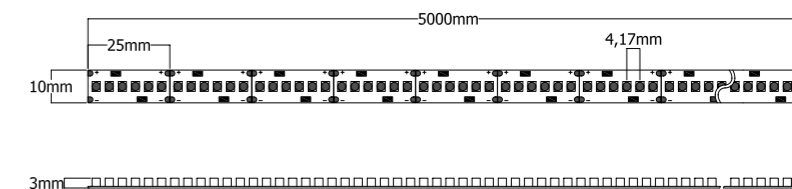

PVP € x m

PVP € x 5m

39,71 € 178,71 €

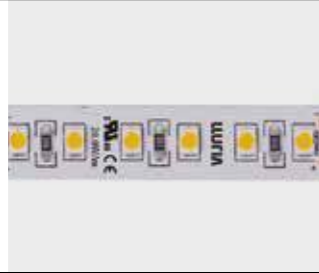

MON-28,8

Moon

- 5 Años Garantía
- 28,8 W/m
- Necesita Disipador
- 50 mm
- 120 LED/m
- LED SMD 2835
- R9 > 10
- CRI > 80
- 24V
- 3 Pasos mcAdams

MON-28,8-27-24	2700K	3170 lm/m
MON-28,8-40-24	4000K	3460 lm/m
MON-28,8-60-24	6000k	3600 lm/m

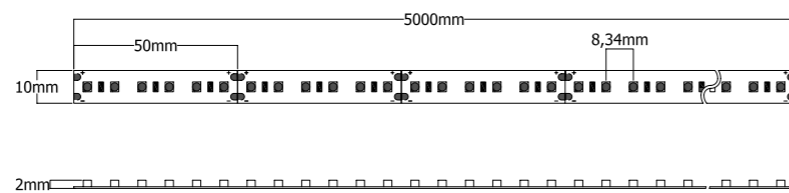

PVP € x m

PVP € x 5m

38,69 € 174,10 €

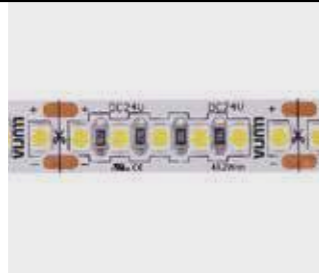

MON-43,2

Moon

- 5 Años Garantía
- 43,2 W/m
- Necesita Disipador
- 33,3 mm
- 180 LED/m
- LED SMD 2835
- R9 > 10
- CRI > 80
- 24V
- 3 Pasos mcAdams

MON-43,2-27-24	2700K	4755 lm/m
MON-43,2-40-24	4000K	5185 lm/m
MON-43,2-60-24	6000k	5400 lm/m

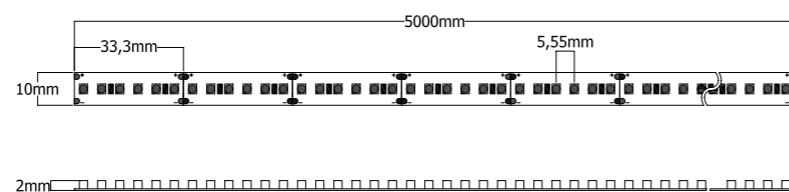

PVP € x m

PVP € x 5m

51,17 € 230,26 €



MON-57,6

Moon

- 5 Años Garantía
- 57,6 W/m
- Necesita Disipador
- 25 mm
- 240 LED/m
- LED SMD 2835
- R9 > 10
- CRI > 80
- 3m
- 24V
- 3 Pasos mcAdams

MON-57,6-27-24	2700K	6340 lm/m
MON-57,6-40-24	4000K	6915 lm/m
MON-57,6-60-24	6000k	7200 lm/m

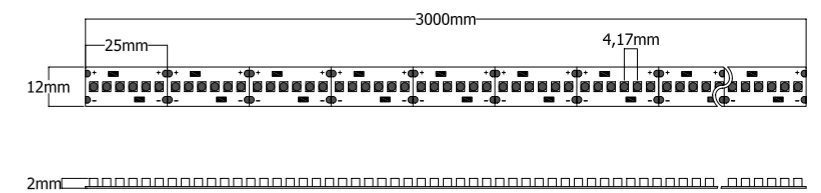

PVP € x m

PVP € x 3m

62,36 € 168,37 € x 3m

Bar Singular
Vizcaya
Tao Iluminación
Erlantz Biderbost

Taberna La Taurina
Vizcaya
Tao Iluminación
Erlantz Biderbost



Titan

Su gran polivalencia lo hace un producto ideal para uso decorativo o espectacular. Con los RGB se consiguen efectos de colores graduales o de acento, con los RGBW se consigue una mayor gama de colores y con la combinación de LED blancos se consigue toda la gama de blancos posibles (CCT). Garantía de 5 años.

Its great versatility makes it an ideal product for decorative or spectacular use. With RGB you can achieve effects of gradient or accent colors, with the RGBW you get a wider range of colors and with the combination of white LEDs you get the full range of possible targets (CCT). 5 year warranty.



TTN-7,2

Titan **RGB**

- 5 Años Garantía
- 7,2 W/m
- 167mm
- 30 LED/m
- LED SMD 5050
- 3 n1
- 24V

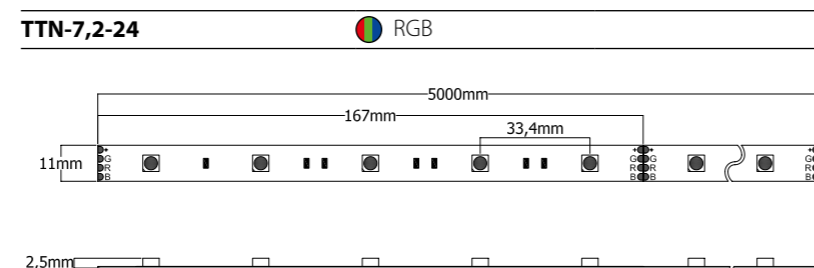

- PVP € x m
- PVP € x 5m
- 17,40 €
- 78,28 €



TTN-14,4

Titan **RGB**

- 5 Años Garantía
- 14,4 W/m
- Necesita Disipador
- 100 mm
- 60 LED/m
- LED SMD 5050
- 3 n1
- 24V

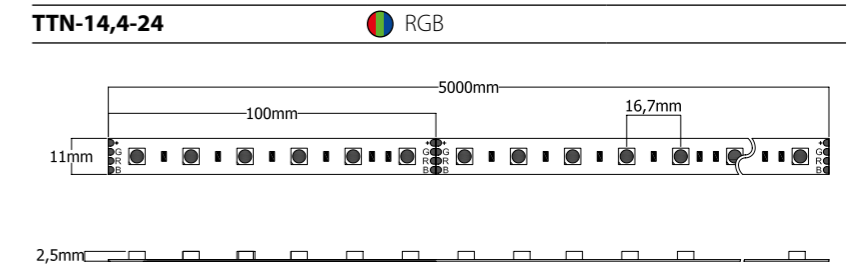

- PVP € x m
- PVP € x 5m
- 27,72 €
- 124,73 €



TTN-19,2

Titan **RGBW**

- 5 Años Garantía
- 19,2 W/m
- Necesita Disipador
- 100 mm
- 60 LED/m
- LED SMD 5050
- 4 n1
- 24V

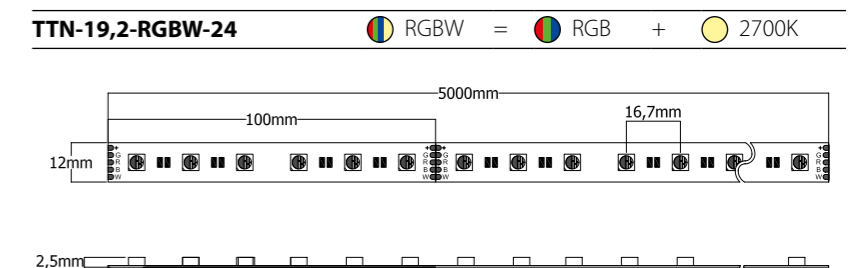

- PVP € x m
- PVP € x 5m
- 55,20 €
- 248,40 €

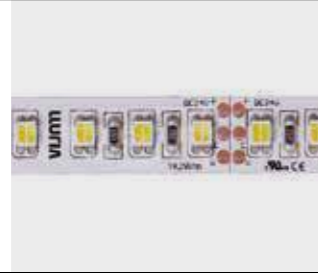

TTN-19,2

Titan **Double white**

- 5 Años Garantía
- 19,2 W/m
- Necesita Disipador
- 50 mm
- 60 LED/m
- LED SMD 3527
- 24V
- 2 n1

TTN-19,2-24-60-24 2400K + 6000K

PVP € x m 55,20 €

PVP € x 5m 248,40 €



TTN-19,2

Titan **Perfect white**

- 5 Años Garantía
- 19,2 W/m
- Necesita Disipador
- 100 mm
- 60 LED/m
- LED SMD 5050
- 4 n1
- 24V

TTN-19,2-R-A-27-55-24 Rojo Red + Ambar Amber + 2700K + 5500K

Amplia gama de blancos (CCT), tonos dorados, cobrizos y ocres.
Wide range of white (CCT), golden tones, copper and ochres.

PVP € x m 60,77 €

PVP € x 5m 273,46 €



Proyecto Clarobscur - Festival LLUM BCN 2017, 1r premio, alumnos 5º Arquitectura UIC.

Snake

Adaptación perfecta a curvas muy pronunciadas o ángulos rectos, letras corpóreas y superficies no uniformes y/o con formas irregulares.
Perfect adaptation to very pronounced curves or right angles, corporeal letters and uneven surfaces and / or irregular shapes.



3 Años Garantía

>80 CRI

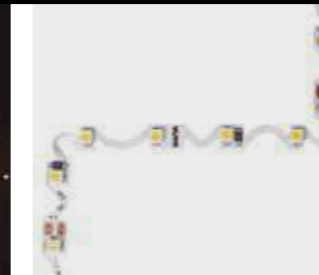
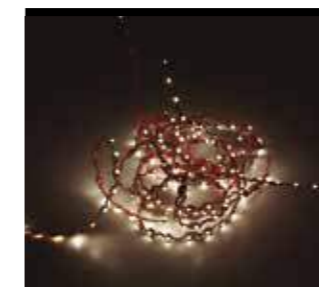

SNK-4,8

Snake

- 3 Años Garantía
- 4,8 W/m
- 100 mm
- 60 LED/m
- LED SMD 3528
- CRI > 80
- 24V

SNK-4,8-27-24 2700K 450 lm/m

SNK-4,8-40-24 4000K 470 lm/m

PVP € x m 24,26 €

PVP € x 5m 109,18 €



SNK-14,2

Snake

- 3 Años Garantía
- 14,2 W/m
- Necesita Disipador
- 100 mm
- 60 LED/m
- LED SMD 2835
- R9 > 10
- CRI > 80
- 24V

SNK-14,2-27-24	● 2700K	1585 lm/m
SNK-14,2-40-24	○ 4000K	1730 lm/m

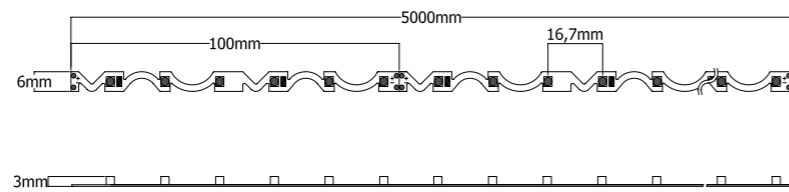

- PVP € x m: 32,78 €
- PVP € x 5m: 147,50 €

Clínica Dental San Vicente
Vizcaya
Tao Iluminación
Erlantz Biderbost



Mini-LED

Dimensiones reducidas perfectas para espacios pequeños o iluminaciones minimalistas. Ancho de tira de 4mm.
Reduced dimensions perfect for small spaces or minimalist lighting. 4mm strip width.



MIN-9,5

Mini-LED

- 3 Años Garantía
- 9,5 W/m
- Necesita Disipador
- 50 mm
- 120 LED/m
- LED SMD 2216
- 24V

MIN-9,5-27-24	● 2700K	700 lm/m
MIN-9,5-40-24	○ 4000K	755 lm/m

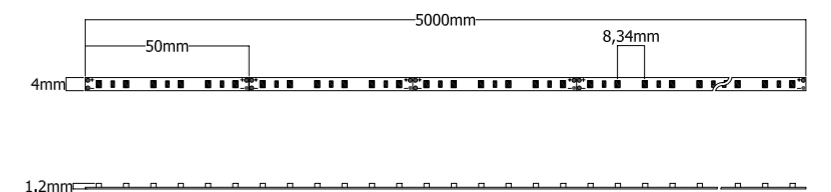

- PVP € x m: 23,37 €
- PVP € x 5m: 105,15 €

Side

Sistema de LED flexible en ángulo de 90° para iluminación lateral, ideal para instalaciones curvas, foseados o zócalos de mobiliario.

90° angle flexible LED system for side lighting, ideal for curved installations, cove lighting or furniture bases.

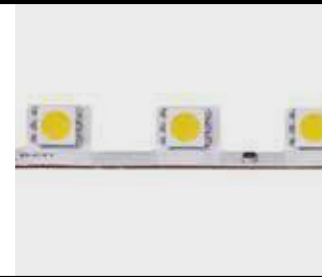

SID-14,4

Side



SID-14,4-27-24	● 2700K	1215 lm/m
SID-14,4-40-24	○ 4000K	1310 lm/m

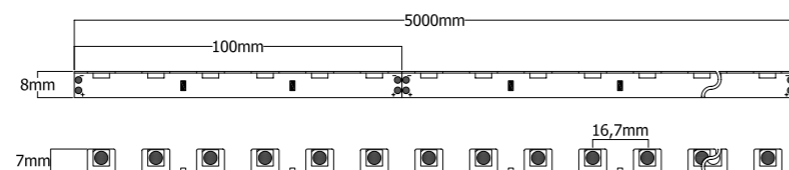

35,65 € 160,43 €

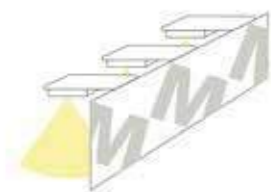

Basic

Sistema de iluminación lineal LED flexible de calidad para uso interior, con 3 años de garantía. Disponible en bobinas de 25 metros (potencias de 4,8, 9,6 y 14,2W/m).

Linear flexible LED lighting system for indoor use with 3 year warranty. Available in 25 meter reels (power 4,8, 9,6 and 14,2W/m).

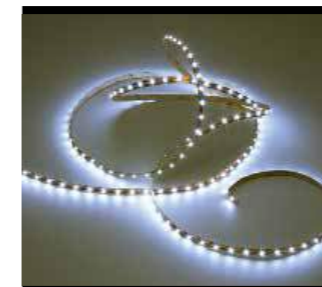

BS-4,8

Basic



BS-4,8-27-24	● 2700K	405 lm/m
BS-4,8-30-24	○ 3000K	415 lm/m
BS-4,8-40-24	○ 4000K	425 lm/m
BS-4,8-55-24	● 5500K	455 lm/m

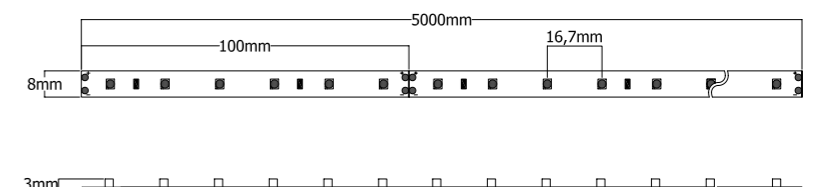

8,40 € 37,80 € 189,00 €

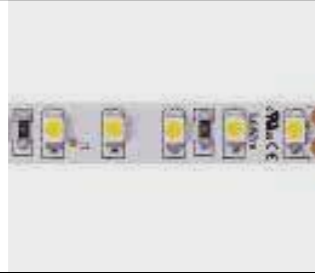

BS-9,6

Basic

3 Años Garantía

9,6 W/m

Necesita Disipador

50 mm

120 LED/m

LED SMD 3528

24V

BS-9,6-27-24	2700K	810 lm/m
BS-9,6-30-24	3000K	825 lm/m
BS-9,6-40-24	4000K	845 lm/m
BS-9,6-55-24	5500K	910 lm/m

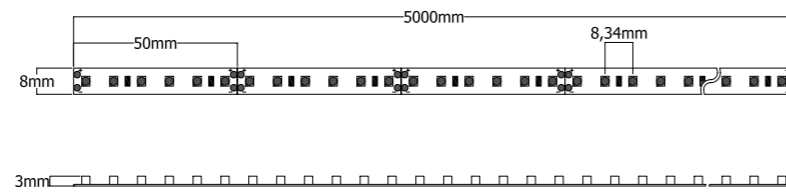

PVP € x m

PVP € x 5m

PVP € x 25m

13,68 € 61,56 € 307,80 €



BS-14,4

Basic

3 Años Garantía

14,4 W/m

Necesita Disipador

100 mm

60 LED/m

LED SMD 5050

24V

BS-14,4-27-24	2700K	1095 lm/m
BS-14,4-30-24	3000K	1135 lm/m
BS-14,4-40-24	4000K	1180 lm/m
BS-14,4-55-24	5500K	1215 lm/m

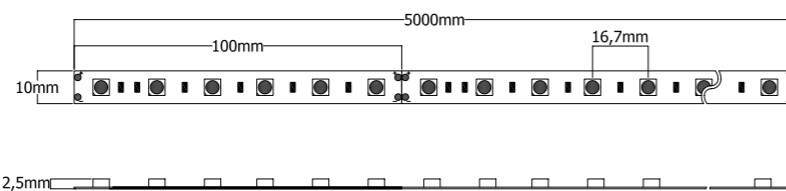

PVP € x m

PVP € x 5m

PVP € x 25m

16,56 € 74,52 € 372,60 €



BS-19,2

Basic

3 Años Garantía

19,2 W/m

Necesita Disipador

25 mm

240 LED/m

LED SMD 3528

24V

BS-19,2-27-24	2700K	1615 lm/m
BS-19,2-30-24	3000K	1645 lm/m
BS-19,2-40-24	4000K	1680 lm/m
BS-19,2-55-24	5500K	1820 lm/m

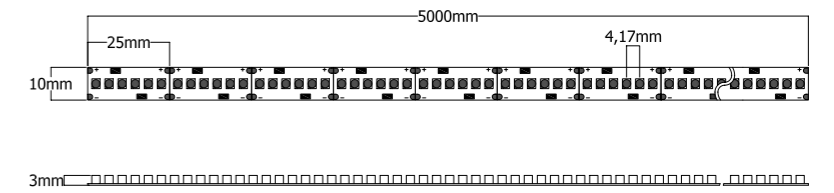

PVP € x m

PVP € x 5m

27,00 € 121,50 €

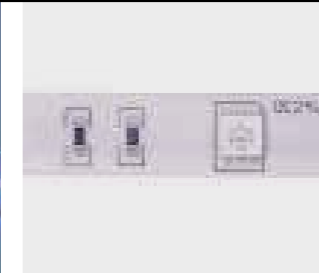

BS-7,2

Basic RGB

3 Años Garantía

7,2 W/m

167 mm

30 LED/m

LED SMD 5050

3 n 1

24V

BS-7,2-RGB-24	RGB
----------------------	-----

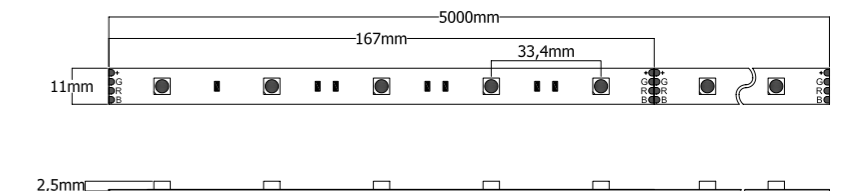

PVP € x m

PVP € x 5m

15,17 € 68,26 €



BS-14,4

Basic RGB

3 Años Garantía	14,4 W/m	Necesita Disipador	100 mm
60 LED/m	LED SMD 5050	3 n 1	24V

BS-14,4-RGB-24

RGB

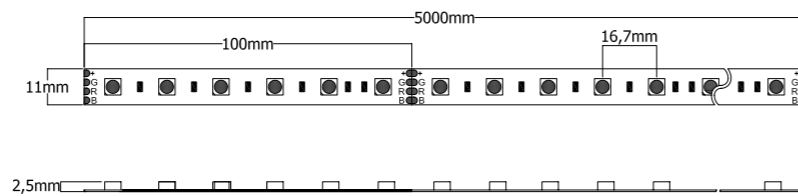

23,04 €



103,70 €

Restaurante Mussol Glòries
Barcelona
Vié Il·luminació



Accesorios Accessories



CR-MON-8

Conector para unión, tira 8mm
Connector for union, strip 8mm

Compatible con MON-4,8 y BS-4,8
Compatible with MON-4,8 and BS-4,8

0,70 €



C-MON-8

Cable con conector, tira 8mm
Wire with connector, strip 8mm

Compatible con MON-4,8 y BS-4,8
Compatible with MON-4,8 and BS-4,8

0,80 €



CD-MON-8

Cable unión con 2 conectores, tira 8mm
Connection wire with 2 connectors, strip 8mm

Compatible con MON-4,8 y BS-4,8
Compatible with MON-4,8 and BS-4,8

1,30 €



CR-MON-10

Conector para unión, tira 10mm
Connector for union, strip 10mm

Compatible con ARI-14,2, MON-14,2 y BS-14,4
Compatible with ARI-14,2, MON-14,2 and BS-14,4

0,70 €



C-MON-10

Cable con conector, tira 10mm
Wire with connector, strip 10mm

Compatible con ARI-14,2, MON-14,2 y BS-14,4
Compatible with ARI-14,2, MON-14,2 and BS-14,4

0,80 €



CD-MON-10

Cable unión con 2 conectores, tira 10mm
Connection wire with 2 connectors

Compatible con ARI-14,2, MON-14,2 y BS-14,4
Compatible with ARI-14,2, MON-14,2 and BS-14,4

1,30 €



CR-RGB

Cable unión con conector, tira RGB
Connection wire with connector, RGB strip

Compatible con TTN-7,2, TTN-14,4, BS-7,2-RGB y BS-14,4-RGB
Compatible with TTN-7,2, TTN-14,4, BS-7,2-RGB and BS-14,4-RGB

0,90 €



C-RGB

Pieza unión, tira RGB
Connecting piece, RGB strip

Compatible con TTN-7,2, TTN-14,4, BS-7,2-RGB y BS-14,4-RGB
Compatible with TTN-7,2, TTN-14,4, BS-7,2-RGB and BS-14,4-RGB

1,30 €



CD-RGB

Cable unión con 2 conectores, tira RGB
Connection wire with 2 connectors, RGB Strip

Compatible con TTN-7,2, TTN-14,4, BS-7,2-RGB y BS-14,4-RGB
Compatible with TTN-7,2, TTN-14,4, BS-7,2-RGB and BS-14,4-RGB

1,70 €



C-H-2H

Cable con conector hembra, 2 hilos
Wire with connector female, 2 threads

Compatible con todas las tiras IP20 monocolor y Gourmet
Compatible with all the IP20 strips monocolor and Gourmet

0,70€



C-M-2H

Cable con conector macho, 2 hilos
Wire with connector male, 2 threads

Compatible con todas las tiras IP20 monocolor y Gourmet
Compatible with all the IP20 strips monocolor and Gourmet

0,70€



C-H-4H

Cable con conector hembra, 4 hilos
Wire with connector female, 4 threads

Compatible con todas las tiras IP20 RGB
Compatible with all the IP20 strips RGB

1,25€



C-M-4H

Cable con conector macho, 4 hilos
Wire with connector male, 4 threads

Compatible con todas las tiras IP20 RGB
Compatible with all the IP20 strips RGB

1,25€

Hotel H10 Urquinaona
Barcelona



LLUMIA

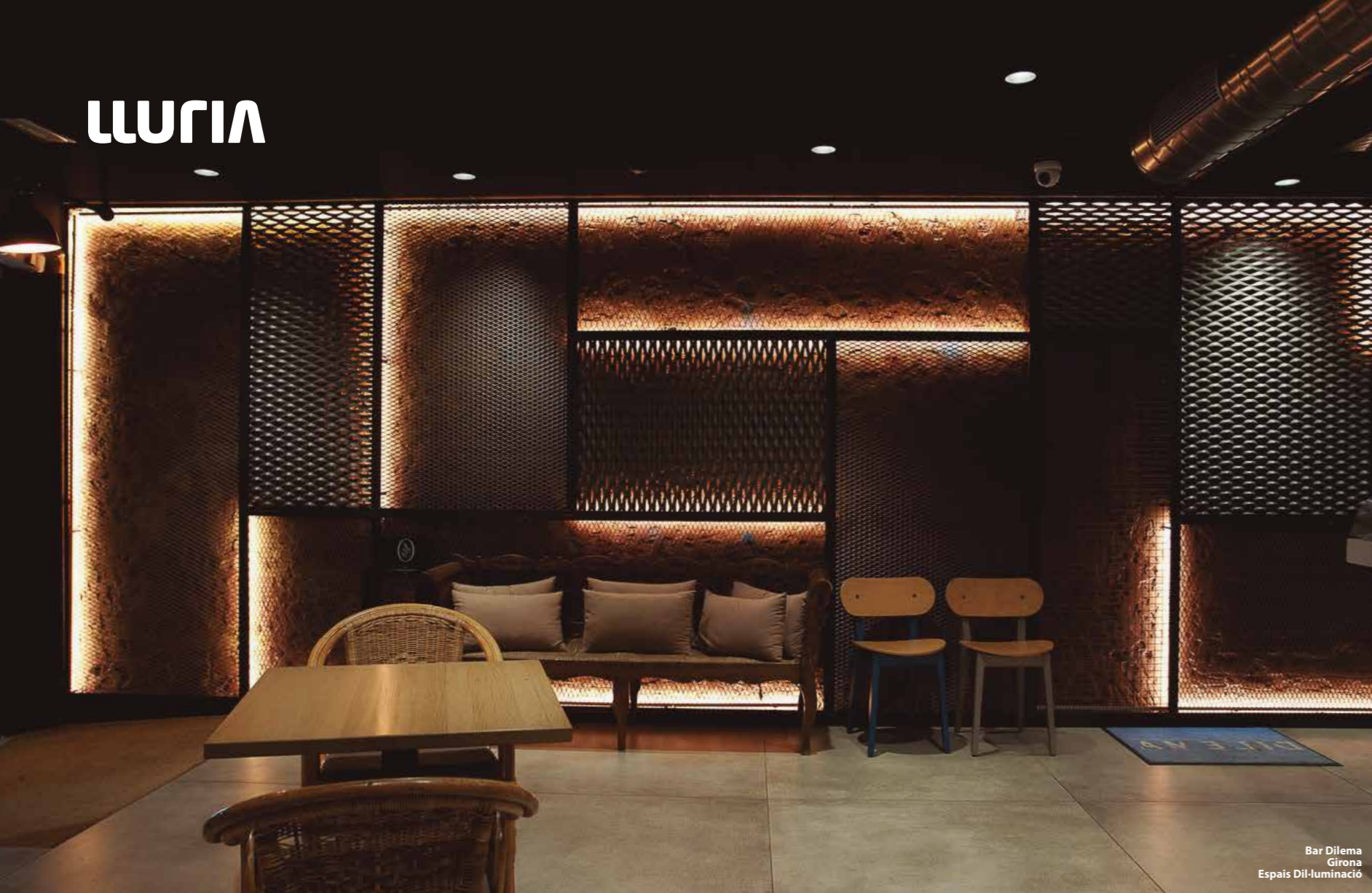

Bar Dilema
Girona
Espais Dii-luminació



Proyecto Claraboscuro - Festival LLUM BCN 2017,
1r premio, alumnos 5º Arquitectura UIC.



SPA Sallés Hotel Cala del Pi
Girona
Espais Dii-luminació

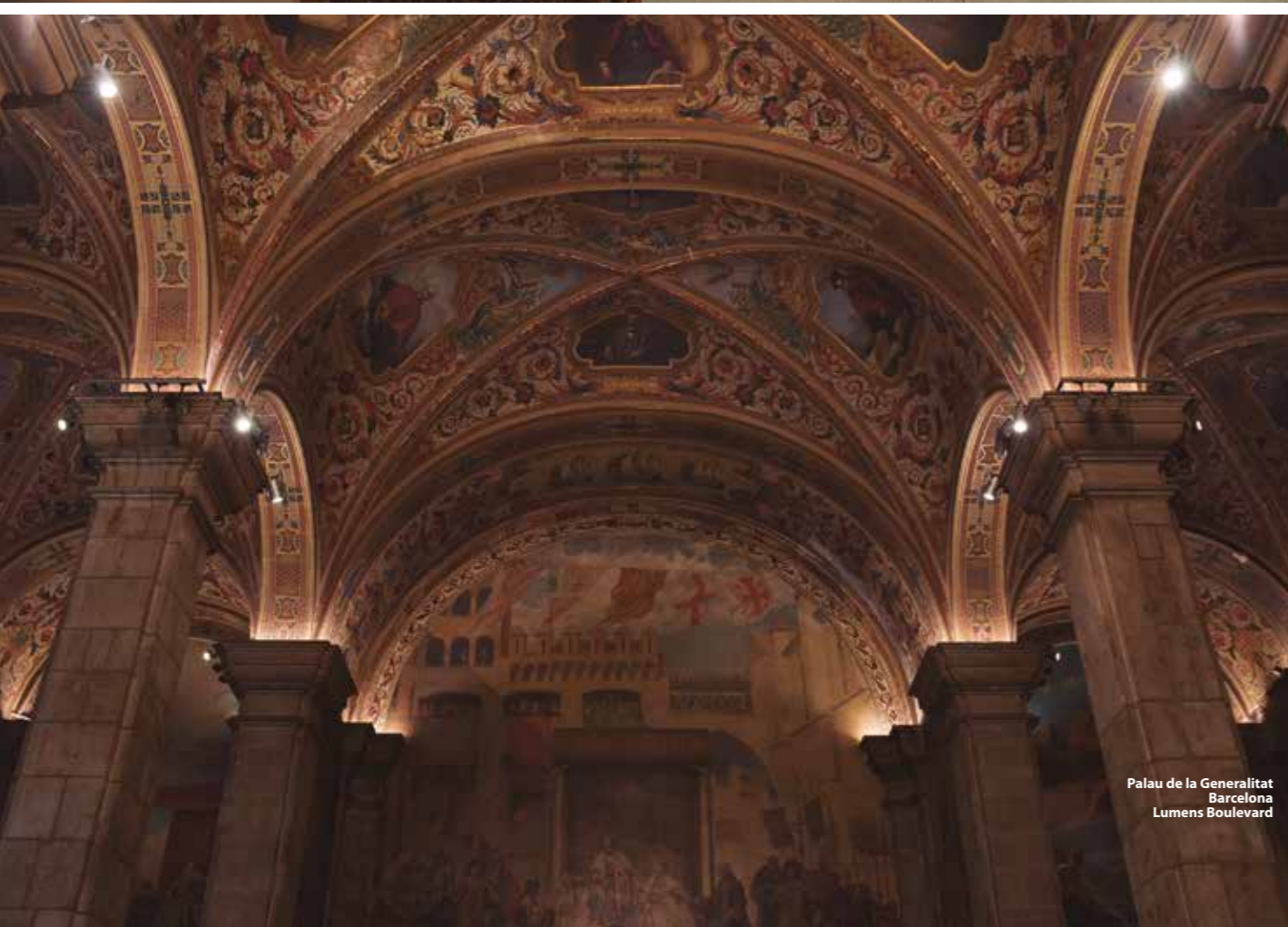

Palau de la Generalitat
Barcelona
Lumens Boulevard



Metro Bilbao
Vizcaya
Susaeata

Protect IP54

Sistema de Iluminación Lineal LED flexible de uso interior con protección de silicona y resistente a salpicaduras de agua*. Amplia gama de potencias, temperaturas y colores.

Flexible indoor LED lighting system with silicone protection and splash-proof water *. Wide range of powers, temperatures and colors.



Comet <i>CRI>80</i>	39
Halley <i>Multi color - Multi CCT</i>	42
Basic IP54	44
Accesorios <i>Accessories</i>	47

***Se puede instalar en zonas húmedas, pero no donde puedan estar prolongadamente expuesta al agua.**
 * It can be installed in wet areas, but not where they may be exposed extensively to water.

Comet

Gama con gran variedad de potencias y colores que lo hacen un producto muy adaptable. Puede señalar y acompañar; o ser la iluminación única o máxima de una estancia. Con una Reproducción Cromática (CRI) superior a 80. Garantía de 5 años.
 Range with great variety of powers and colors that make it a very adaptable product. Can signal and back light; Or be the single or maximum illumination of a room. With Chromatic Reproduction (CRI) greater than 80. 5 year warranty.



CMT-4,8

Comet IP54



CMT-4,8-23-24	● 2300K	395 lm/m
CMT-4,8-27-24	● 2700K	405 lm/m
CMT-4,8-40-24	○ 4000K	425 lm/m
CMT-4,8-55-24	○ 5500K	455 lm/m
CMT-4,8-AB-24	● Ambar Amber	
CMT-4,8-AZ-24	● Azul Blue	
CMT-4,8-RJ-24	● Rojo Red	
CMT-4,8-UV-24	● Ultravioleta Ultraviolet	
CMT-4,8-VD-24	● Verde Green	

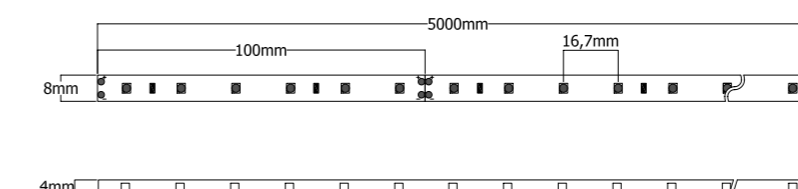

16,19 € 68,80 €



CMT-9,6

Comet IP54

5 Años Garantía

9,6 W/m

Necesita Disipador

50 mm

120 LED/m

LED SMD 3528

CRI > 80

24V

3 Pasos mcAdams

CMT-9,6-23-24	2300K	780 lm/m
CMT-9,6-27-24	2700K	810 lm/m
CMT-9,6-40-24	4000K	845 lm/m
CMT-9,6-55-24	5500K	910 lm/m

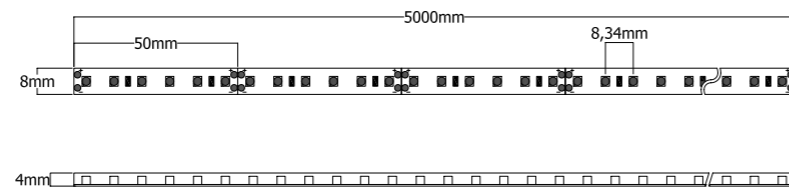

PVP € x m

PVP € x 5m

26,42 € 112,27 €



CMT-13,9

Comet IP54

5 Años Garantía

13,9 W/m

Necesita Disipador

33,3 mm

180 LED/m

LED SMD 3528

CRI > 80

24V

3 Pasos mcAdams

CMT-13,9-23-24	2300K	1170 lm/m
CMT-13,9-27-24	2700K	1210 lm/m
CMT-13,9-40-24	4000K	1260 lm/m
CMT-13,9-55-24	5500K	1365 lm/m

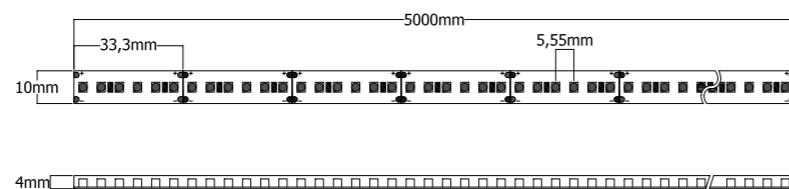

PVP € x m

PVP € x 5m

36,67 € 165,00 €



CMT-14,2

Comet IP54

5 Años Garantía

14,2 W/m

Necesita Disipador

100 mm

60 LED/m

LED SMD 2835

R9 > 10

CRI > 80

24V

3 Pasos mcAdams

CMT-14,2-23-24	2300K	1350 lm/m
CMT-14,2-27-24	2700K	1430 lm/m
CMT-14,2-40-24	4000K	1560 lm/m
CMT-14,2-60-24	6000K	1620 lm/m
CMT-14,2-AB-24	Ambar Amber	
CMT-14,2-AZ-24	Azul Blue	
CMT-14,2-RJ-24	Rojo Red	
CMT-14,2-UV-24	Ultravioleta Ultraviolet	
CMT-14,2-VD-24	Verde Green	

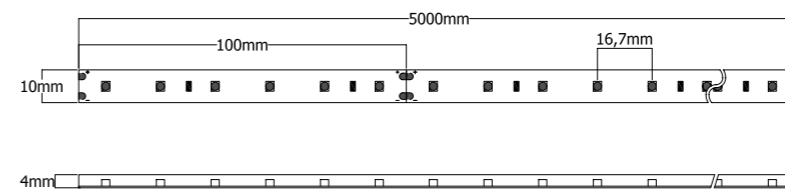

PVP € x m

PVP € x 5m

30,13 € 128,03 €



CMT-28,8

Comet IP54

5 Años Garantía

28,8 W/m

Necesita Disipador

50 mm

120 LED/m

LED SMD 2835

R9 > 10

CRI > 80

24V

3 Pasos mcAdams

CMT-28,8-27-24	2700K	2855 lm/m
CMT-28,8-40-24	4000K	3115 lm/m
CMT-28,8-60-24	6000k	3240 lm/m

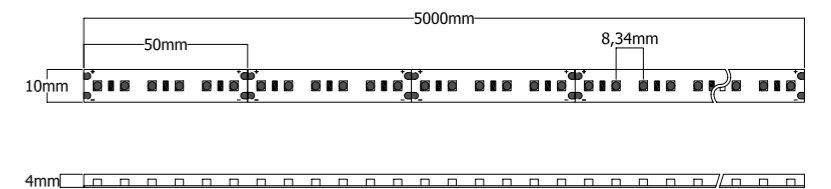

PVP € x m

PVP € x 5m

45,32 € 192,62 €

Halley

Producto específico para iluminación decorativa y espectacular, con efectos RGB y/o RGB + blanco que permite generar una mayor gama de colores. Garantía de 5 años.

Specific product for decorative or spectacular lighting, with RGB and/or RGB + white effects that allows to generate a greater range of colors. 5 year warranty.



HLL-7,2

Halley IP54 **RGB**

- 5 Años Garantía
- 7,2 W/m
- 167mm
- 30 LED/m
- LED SMD 5050
- 3 n1
- 24V

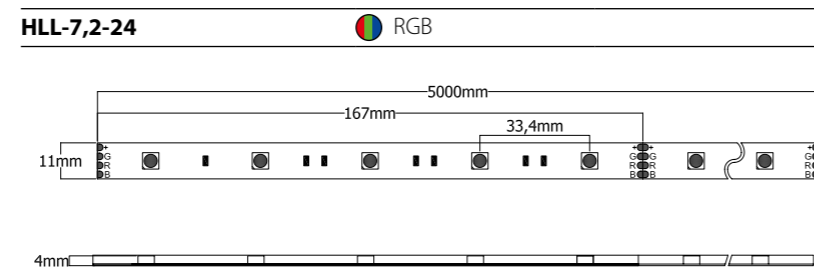

- PVP € x m
- PVP € x 5m
- 23,02 €
- 97,85 €



HLL-14,4

Halley IP54 **RGB**

- 5 Años Garantía
- 14,4 W/m
- Necesita Disipador
- 100 mm
- 60 LED/m
- LED SMD 5050
- 3 n1
- 24V

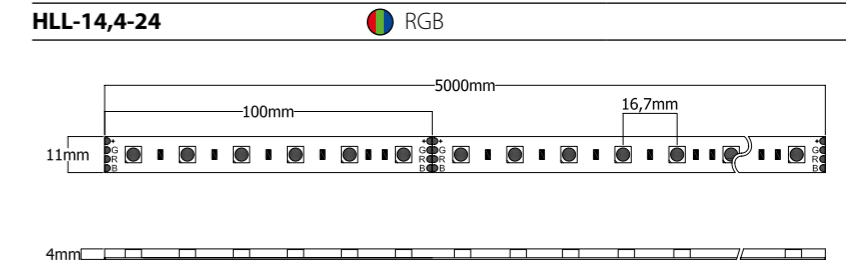

- PVP € x m
- PVP € x 5m
- 33,74 €
- 143,38 €



HLL-19,2

Halley IP54 **RGBW**

- 5 Años Garantía
- 19,2 W/m
- Necesita Disipador
- 100 mm
- 60 LED/m
- LED SMD 3528
- 4 n1
- 24V

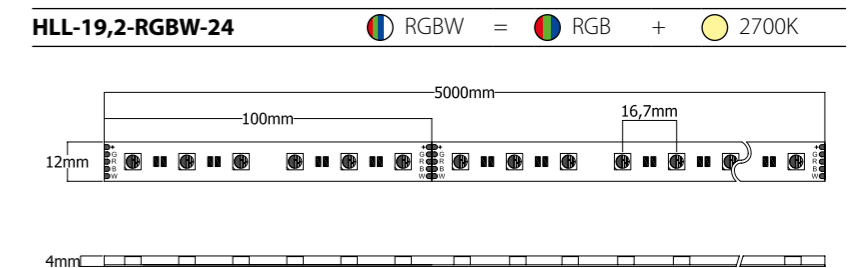

- PVP € x m
- PVP € x 5m
- 61,09 €
- 259,63 €

Basic IP54

Sistema de iluminación lineal LED flexible de calidad para uso interior con protección de silicona y resistente a salpicaduras de agua*. Amplia gama de potencias, temperaturas y colores. 3 años de garantía.

Linear flexible LED lighting system for indoor with silicone protection and splash-proof water*. Wide range of powers, temperatures and colors. 3 year warranty.



*Se puede instalar en zonas húmedas, pero no donde puedan estar prolongadamente expuesta al agua.
*It can be installed in wet areas, but not where they may be exposed extensively to water.



BSE-4,8

Basic IP54

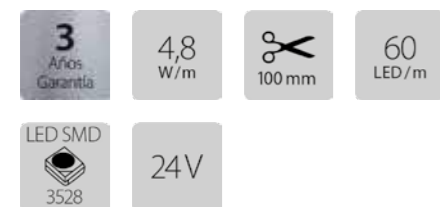

BSE-4,8-27-24	● 2700K	385 lm/m
BSE-4,8-30-24	○ 3000K	395 lm/m
BSE-4,8-40-24	○ 4000K	400 lm/m
BSE-4,8-55-24	○ 5500K	430 lm/m

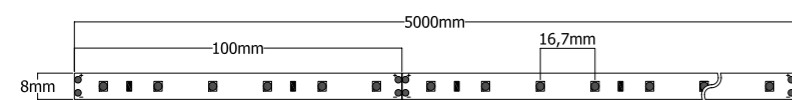

BSE-9,6

Basic IP54



BSE-9,6-27-24	● 2700K	765 lm/m
BSE-9,6-30-24	○ 3000K	780 lm/m
BSE-9,6-40-24	○ 4000K	795 lm/m
BSE-9,6-55-24	○ 5500K	860 lm/m

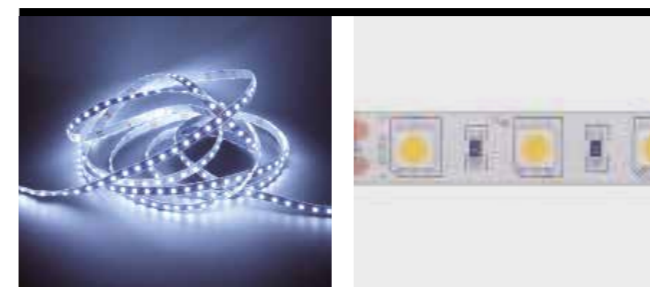
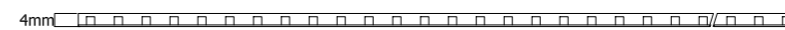

BSE-14,4

Basic IP54



BSE-14,4-27-24	● 2700K	1035 lm/m
BSE-14,4-30-24	○ 3000K	1075 lm/m
BSE-14,4-40-24	○ 4000K	1115 lm/m
BSE-14,4-55-24	○ 5500K	1150 lm/m

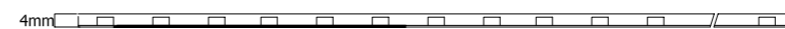
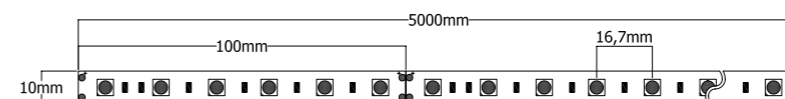

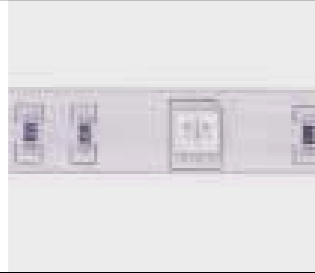

BSE-7,2

Basic IP54 **RGB**

- 3** Años Garantía
- 7,2** W/m
- 167mm
- 30** LED/m
- LED SMD 5050
- 3 n1
- 24V**

BSE-7,2-RGB-24

RGB

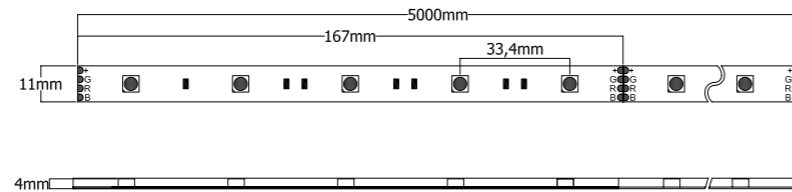

- PVP € x m
- PVP € x 5m

20,82 € 88,51 €



BSE-14,4

Basic IP54 **RGB**

- 3** Años Garantía
- 14,4** W/m
- Necesita Disipador
- 100mm
- 60** LED/m
- LED SMD 5050
- 3 n1
- 24V**

BSE-14,4-RGB-24

RGB

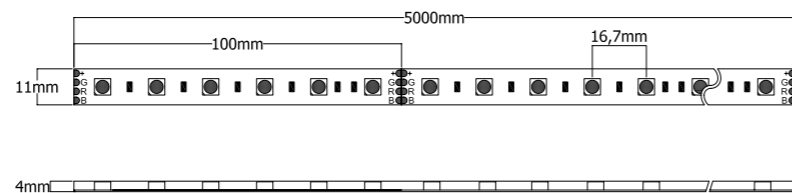

- PVP € x m
- PVP € x 5m

26,78 € 113,80 €

Accesorios Accessories



C-H-2H-IP67

Cable + conector hembra ip67, 2 hilos
Wire + female connector IP67, 2 threads

Compatible con todas las tiras IP54 y IP67 monocolor
Compatible with all the IP54 and IP67 strips monocolor

3,60 €



C-M-2H-IP67

Cable + conector macho ip67, 2 hilos
Wire + male connector IP67, 2 threads

Compatible con todas las tiras IP54 y IP67 monocolor
Compatible with all the IP54 and IP67 strips monocolor

3,60 €



C-H-4H-IP67

Cable + conector hembra ip67, 4 hilos
Wire + female connector IP67, 4 threads

Compatible con todas las tiras IP54 y IP67 RGB
Compatible with all IP54 and IP67 RGB strips

5,12 €



C-M-4H-IP67

Cable + conector macho ip67, 4 hilos
Wire + male connector IP67, 4 threads

Compatible con todas las tiras IP54 y IP67 RGB
Compatible with all IP54 and IP67 RGB strips

5,12 €

LLURIA



Sallés Hotel & Spa Mas Tapiolas
Girona
Espais D'Il·luminació

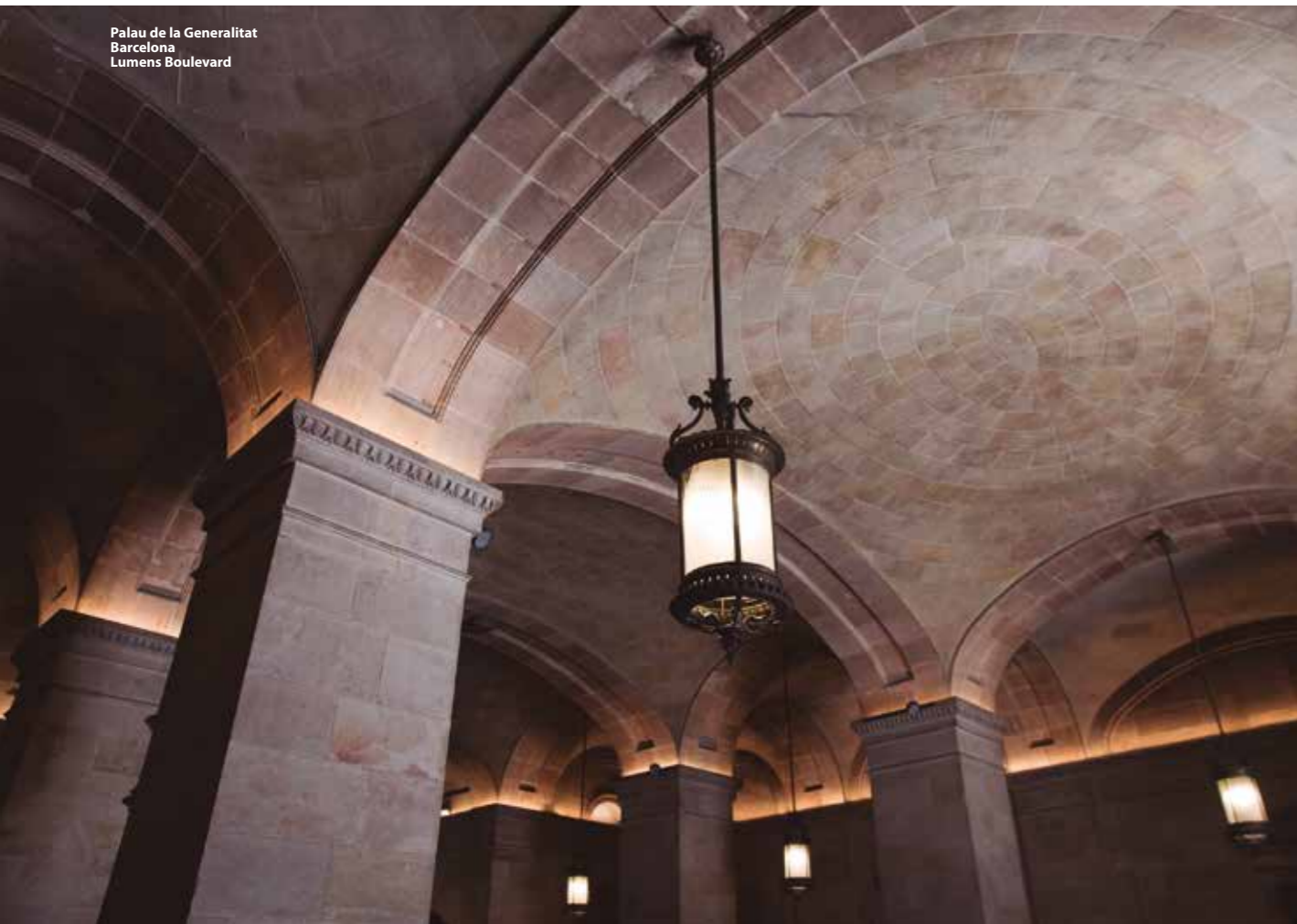

Palau de la Generalitat
Barcelona
Lumens Boulevard



Avenida Sofia Hotel Boutique & Spa Sitges
Barcelona

Waterproof IP67

Sistema de iluminación Lineal LED para uso interior o exterior. Con recubrimiento de silicona especial de transmisión térmica que cubre todo el circuito impreso y sus componentes. Capaz de soportar cambios de temperatura y lluvia. Con una amplia gama de potencias, temperaturas y colores. Garantía de 5 años.

Linear LED lighting system for indoor or outdoor use. With special silicone, thermal transfer coating covering the entire printed circuit and its components. Able to withstand changes in temperature and rainfall. With a wide range of powers, temperatures and colors. 5 year warranty.

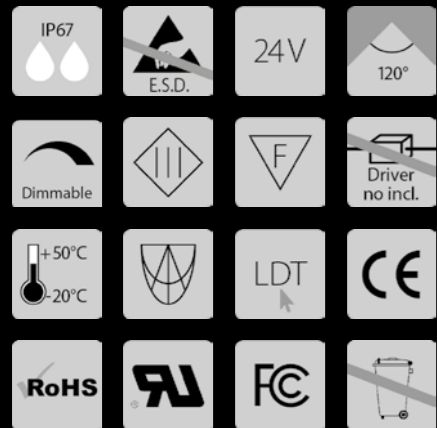

Energy IP67 150 lm/w 51
 Luxel CRI>80 y Multi color 53
 Accesorios Accessories 58

Waterproof IP67

Energy IP67

Sistema de alta intensidad lumínica y excelente uniformidad. Se trata del sistema más eficiente. Con rendimiento de 150 lm/w. Garantía de 5 años. System of high luminous intensity and excellent uniformity. This is the most efficient system. With a performance of 150 lm/w. 5 Year Warranty.

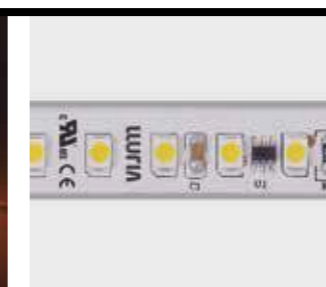

ENE-20

Energy IP67



ENE-20-27-24	2700K	2745 lm/m
ENE-20-40-24	4000K	2965 lm/m
ENE-20-60-24	6000K	3090 lm/m

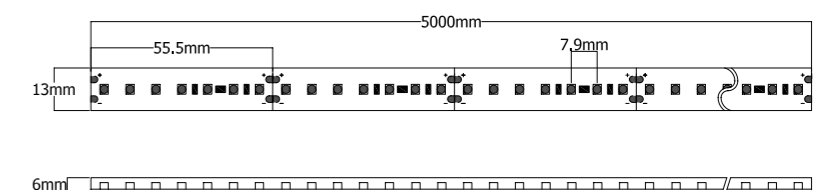

72,94 € 310,00 €



ENE-37

Energy IP67

5 Años Garantía	37 W/m	Necesita Disipador	29,5mm
238 LED/m	LED SMD 2835	R9 > 10	CRI > 80
150 lm/w	24V	3 Pasos mcAdams	

ENE-37-27-24	2700K	5180 lm/m
ENE-37-40-24	4000K	5605 lm/m
ENE-37-60-24	6000K	5835 lm/m

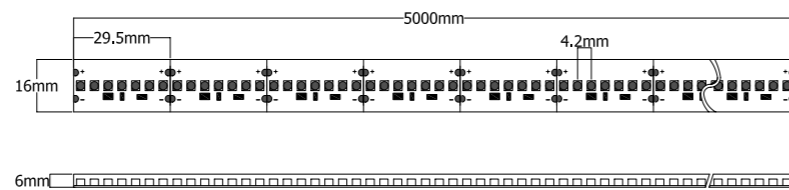

PVP € x m	PVP € x 5m
136,47 €	580,00 €

Pasarela Barrio de La Paz, Sestao Vizcaya Aelvasa



Luxel

Iluminación LED lineal con gran variedad de potencias y colores, ideal para adaptarse a las necesidades de instalaciones de exterior e interior. Garantía de 5 años. Linear LED illumination with great variety of powers and colors, ideal to adapt to the needs of outdoor and indoor installations. 5 Year Warranty.



5 Años garantía	>80 CRI	3 Pasos mcAdams
-----------------	---------	-----------------



LXL-4,8

Luxel IP67

5 Años Garantía	4,8 W/m	100 mm	60 LED/m
LED SMD 3528	CRI > 80	24V	3 Pasos mcAdams

LXL-4,8-23-24	2300K	395 lm/m
LXL-4,8-27-24	2700K	405 lm/m
LXL-4,8-40-24	4000K	425 lm/m
LXL-4,8-55-24	5500K	455 lm/m
LXL-4,8-AB-24	Ambar Amber	
LXL-4,8-AZ-24	Azul Blue	
LXL-4,8-RJ-24	Rojo Red	
LXL-4,8-UV-24	Ultravioleta Ultraviolet	
LXL-4,8-VD-24	Verde Green	

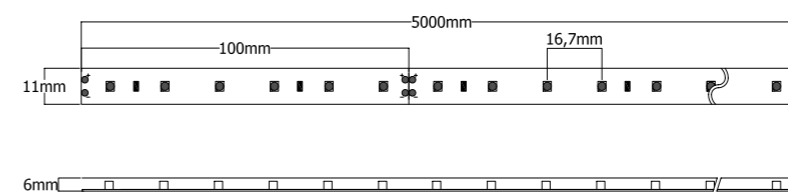

PVP € x m	PVP € x 5m
18,74 €	79,66 €

LXL-9,6

Luxel IP67



- 5 Años Garantía
- 9,6 W/m
- Necesita Disipador
- 50 mm
- 120 LED/m
- LED SMD 3528
- CRI > 80
- 24V
- 3 Pasos mcAdams

LXL-9,6-23-24	2300K	780 lm/m
LXL-9,6-27-24	2700K	810 lm/m
LXL-9,6-40-24	4000K	845 lm/m
LXL-9,6-55-24	5500K	910 lm/m

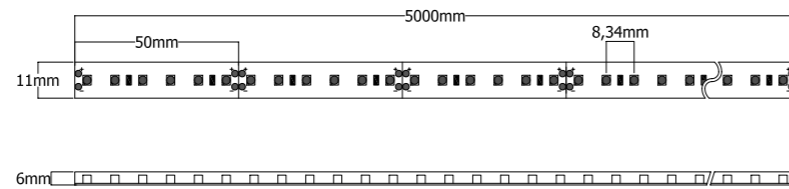

- PVP € x m
- PVP € x 5m
- 29,12 €
- 123,76 €

LXL-28,8

Luxel IP67



- 5 Años Garantía
- 28,8 W/m
- Necesita Disipador
- 50 mm
- 120 LED/m
- LED SMD 2835
- R9 > 10
- CRI > 80
- 24V
- 3 Pasos mcAdams

LXL-28,8-27-24	2700K	2855 lm/m
LXL-28,8-40-24	4000K	3115 lm/m
LXL-28,8-60-24	6000K	3240 lm/m

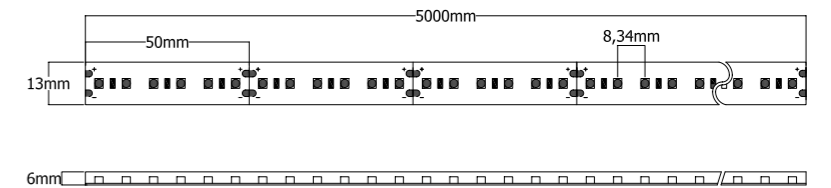

- PVP € x m
- PVP € x 5m
- 46,45 €
- 197,39 €

LXL-14,2

Luxel IP67



- 5 Años Garantía
- 14,2 W/m
- Necesita Disipador
- 100 mm
- 60 LED/m
- LED SMD 2835
- R9 > 10
- CRI > 80
- 24V
- 3 Pasos mcAdams

LXL-14,2-23-24	2300K	1350 lm/m
LXL-14,2-27-24	2700K	1430 lm/m
LXL-14,2-40-24	4000K	1560 lm/m
LXL-14,2-60-24	6000K	1620 lm/m

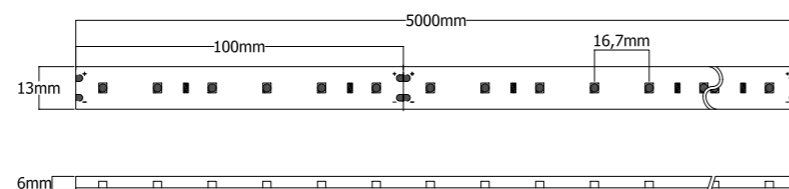

- PVP € x m
- PVP € x 5m
- 32,22 €
- 145,00 €

LXL-43,2

Luxel IP67

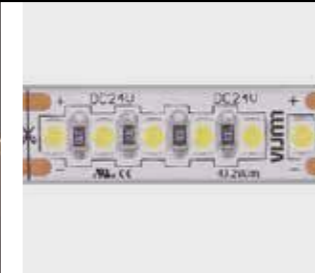

- 5 Años Garantía
- 43,2 W/m
- Necesita Disipador
- 33,3 mm
- 180 LED/m
- LED SMD 2835
- R9 > 10
- CRI > 80
- 24V
- 3 Pasos mcAdams

LXL-43,2-27-24	2700K	4280 lm/m
LXL-43,2-40-24	4000K	4670 lm/m
LXL-43,2-60-24	6000K	4860 lm/m

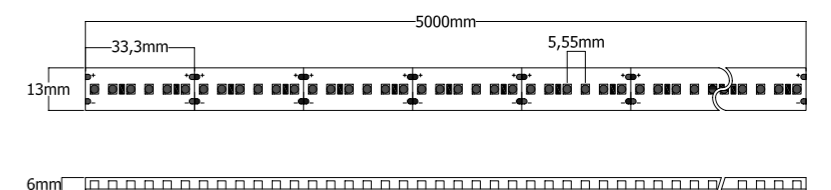

- PVP € x m
- PVP € x 5m
- 59,17 €
- 251,47 €



LXL-57,6

Luxel IP67

- 5 Años Garantía
- 57,6 W/m
- Necesita Disipador
- 25mm
- 240 LED/m
- LED SMD 2835
- R9 > 10
- CRI > 80
- 3m
- 24V
- 3 Pasos mcAdams

LXL-57,6-27-24	2700K	5710 lm/m
LXL-57,6-40-24	4000K	6225 lm/m
LXL-57,6-60-24	6000K	6480 lm/m

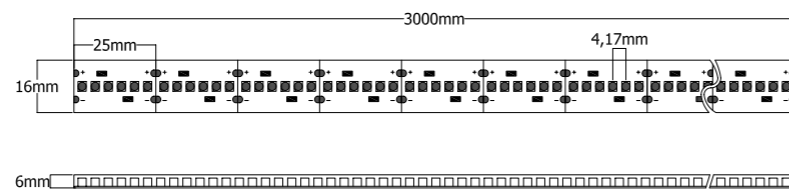

PVP € x m

PVP € x 3m

69,01 €

175,97 € x 3m



LXL-7,2

Luxel IP67 RGB

- 5 Años Garantía
- 7,2 W/m
- 167mm
- 30 LED/m
- LED SMD 5050
- 3 n 1
- 24V

LXL-7,2-RGB-24	RGB
-----------------------	-----

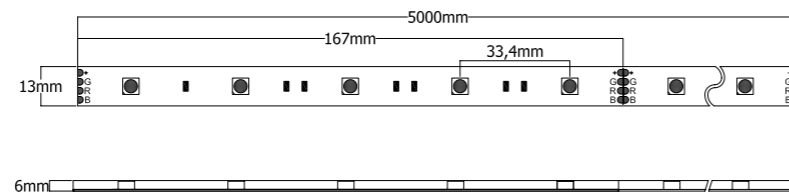

PVP € x m

PVP € x 5m

25,74 €

109,41 €



LXL-14,4

Luxel IP67 RGB

- 5 Años Garantía
- 14,4 W/m
- Necesita Disipador
- 100 mm
- 60 LED/m
- LED SMD 5050
- 3 n 1
- 24V

LXL-14,4-RGB-24	RGB
------------------------	-----

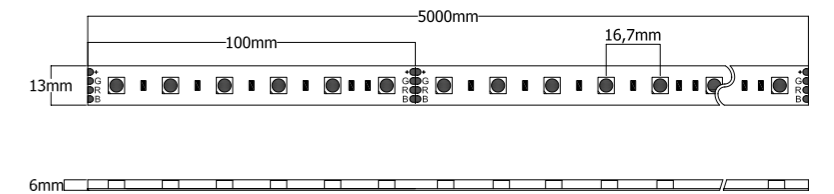

PVP € x m

PVP € x 5m

35,73 €

151,84 €

Fachada Avinyó
Barcelona
DLLUM BCN



Accesorios Accessories



C-H-2H-IP67

Cable + conector hembra ip67, 2 hilos
Wire + female connector IP67, 2 threads

Compatible con todas las tiras IP54 y IP67 monocolor
Compatible with all the IP54 and IP67 strips monocolor

3,60 €



C-M-2H-IP67

Cable + conector macho ip67, 2 hilos
Wire + male connector IP67, 2 threads

Compatible con todas las tiras IP54 y IP67 monocolor
Compatible with all the IP54 and IP67 strips monocolor

3,60 €



C-H-4H-IP67

Cable + conector hembra ip67, 4 hilos
Wire + female connector IP67, 4 threads

Compatible con todas las tiras IP54 y IP67 RGB
Compatible with all IP54 and IP67 RGB strips

5,12 €



C-M-4H-IP67

Cable + conector macho ip67, 4 hilos
Wire + male connector IP67, 4 threads

Compatible con todas las tiras IP54 y IP67 RGB
Compatible with all IP54 and IP67 RGB strips

5,12 €



LLURIA



Colegio Europa, Getxo
Vizcaya
Tao Iluminación
Erlantz Biderbost



Sallés Hotel & Spa Mas Tapiolas
Girona
Espais D'Il·luminació



Sallés Hotel & Spa Mas Tapiolas
Girona
Espais D'Il·luminació



Avenida Sofia Hotel Boutique & Spa Sitges
Barcelona

Underwater IP68

Sistema de Iluminación Lineal LED para uso interior o exterior. Es sumergible e IK08.

LED Linear Lighting System for indoor or outdoor use. Suitable for use under water and IK08.



Wolf Flex + IK08	63
Resiled Resinado / Resin	66
Accesorios Accessories	67

Underwater IP68

Wolf

Cuerpo lineal flexible de luz uniforme sin puntos visibles que permite instalaciones curvadas. Sumergible hasta 1m e IK08. Garantía de 3 años.
Flexible linear body of uniform light without visible points that allows curved installations. Waterproof up to 1m and IK08. 3 year warranty.



WLF-12

Wolf



WLF-12-30	3000k	480 lm/m
WLF-12-55	5500k	520 lm/m
WLF-12-RGB	RGB	

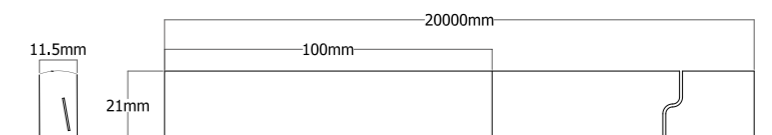

€ x m	€ x 20 m	€ x m	€ x 20 m
122,94 €	2.341,81 €	134,38 €	2.559,76 €

Accesorios Wolf Accessories Wolf



WLF-CN68-D

Conector IP68 derecho, largo de cable 3m
Right connector IP68, wire length 3m
13,18 €

WLF-CN68-I

Conector IP68 izquierdo, largo de cable 3m
Left connector IP68, wire length 3m
13,18 €

WLF-CN68-RGB-D

Conector RGB IP68 derecho
Right connector IP68 RGB
14,63 €

WLF-CN68-RGB-I

Conector RGB IP68 izquierdo
Left connector IP68 RGB
14,63 €



WLF-TP68

Tapa IP68
Top IP68
6,18 €

WLF-TP68-RGB

Tapa IP68
Top IP68
8,04 €



WLF-UN68

Cable unión con conectores
Union wire with connectors
26,37 €

WLF-UN68-RGB

Cable unión con conectores RGB
Union wire with connectors RGB
27,37 €



WLF-PF

1m perfil aluminio, modelo wolf
1m aluminum profile, wolf model
9,17 €

WLF-PF/5

5cm perfil aluminio, modelo wolf
5cm aluminum profile, wolf model
1,25 €

Resiled

Resinado especial en poliuretano con protección UV y tratamiento anti-envejecimiento para las tiras IP54, montadas sobre cualquiera de nuestros perfiles. Se consigue una máxima protección y transparencia. Se mantiene la calidad y la intensidad lumínica.

Special resin in polyurethane with UV protection and anti-aging treatment for IP54 strips, mounted on any of our profiles. Maximum protection and transparency is achieved. Quality and light intensity maintained.



Accesorios IP68 Accessories IP68



PAG-2H

Caja conexión 2 hilos
Box connection 2 threads

Compatible con todas las tiras monocolor
Compatible with all the monocolour strips

20,48 €

PAG-4H

Caja conexión 4 hilos
Box connection 4 threads

Compatible con las tiras RGB
Compatible with all the RGB strips

26,26 €



LLURIA



Discoteca Passarel·la
Girona
Il·lumina Sum



Túnel MiramArt, San Sebastián
Guipúzcoa
Arquitecto: X. Barrutieta
Artista: V. Goikoetxea
Aelvasa



Túnel MiramArt, San Sebastián
Guipúzcoa
Arquitecto: X. Barrutieta
Artista: V. Goikoetxea
Aelvasa

Gourmet

Sistema de iluminación lineal LED flexible específicamente desarrollado para iluminar productos alimentarios.

Flexible LED linear lighting system specifically developed to illuminate food products.



- Pink *Carne / Meat* 71
- Gold *Panadería / Bakery and pastry* 71
- Deli *Cocinados / Pre-cooked food* 72
- Fresh *Frutas y verduras / Fruits and vegetables* 72

Gourmet

Pink

PNK-19,2



PNK-19,2-24 ● Pink 1600 lm/m

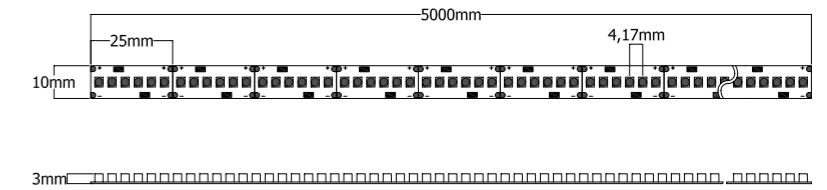

PVP € x m 40,06 €
PVP € x 5m 180,25 €

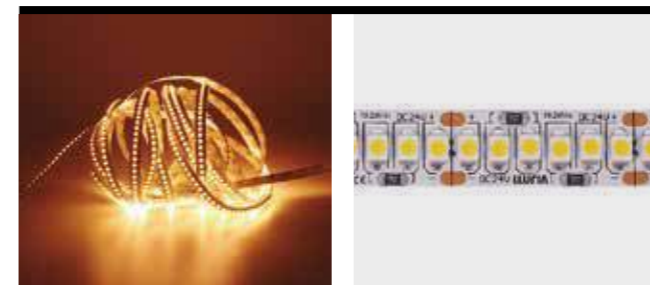

GLD-19,2-24-24 ● 2400k 1645 lm/m

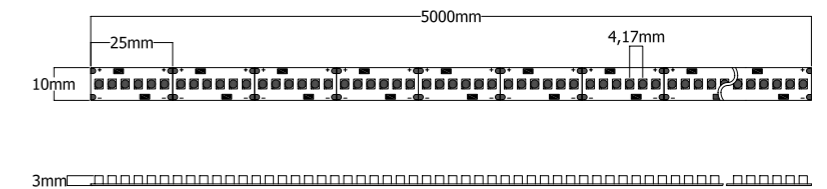

PVP € x m 40,06 €
PVP € x 5m 180,25 €

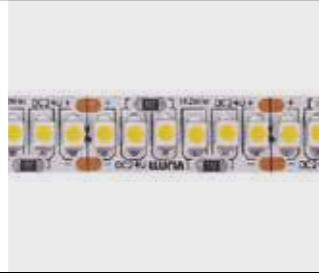

Deli

DEL-19,2

- 5 Años Garantía
- 19,2 W/m
- Necesita Disipador
- 25mm
- 240 LED/m
- LED SMD 3528
- 24V

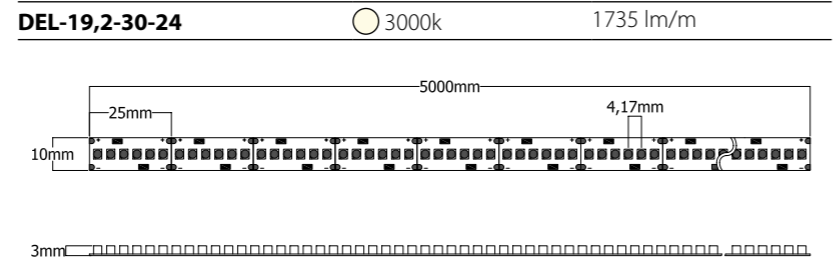

PVP € x m PVP € x 5m

47,61 € 214,24 €



Fresh

FRE-19,2

- 5 Años Garantía
- 19,2 W/m
- Necesita Disipador
- 25mm
- 240 LED/m
- LED SMD 3528
- 24V

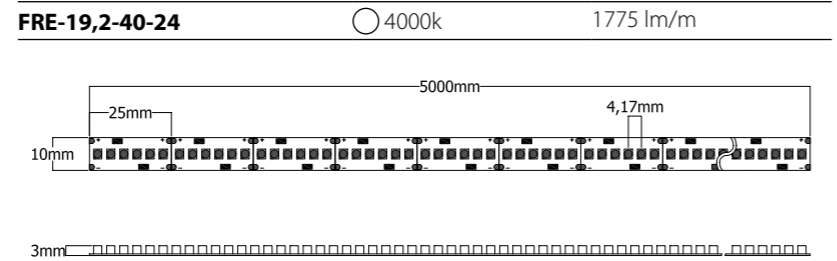

PVP € x m PVP € x 5m

47,61 € 214,24 €



Carnisseria Arnall
Girona
Espais Dil·luminació

Pink

Perfiles *Profiles*

Amplia gama de perfiles tanto de superficie como para empotrar. Diseño propio de sistemas de disipación de calor para Iluminación Lineal LED, accesorios y soportes para instalar. Fabricados con una aleación personalizada y anodizado que proporciona una capa que protege el aluminio contra el óxido.

Wide range of profiles both surface and recess. Own design of heat dissipation systems, accessories and supports to install. Made with a custom anodized alloy that provides a coat that protects aluminum against rust.

Superficie

Star 0	79
Star 1	79
Star 2	80
Star 2D	81
Star 3	82
Star 4	83
Star 6	84
Star 7	85
Star 9	86
Star 10	87
Star 11	88
Star 12	89
Star 14	90
Star 15	92
Star 16	93
Star 17	94
Star 18	95
Star 19 flex	96
Star 20 round	97
2 Sides	100

Empotrable

Star 50	105
Star 51	106
Star 52	107
Star 54	108
Star 55	109
Star 56	110

Índice de Perfiles de Superficie Surface profiles index

Escala 1:1
Scale 1:1

Star0



Star1

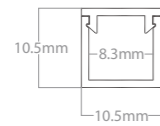

Star2

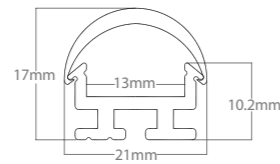

Star2D

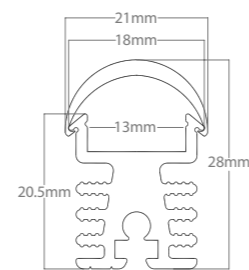

Star3

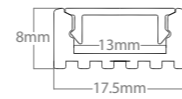

Star4

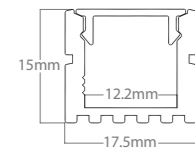

Star6

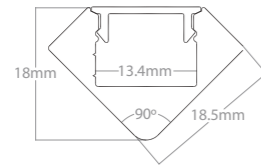

Star7

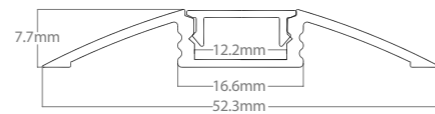

Star9

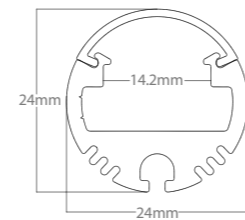

Star10

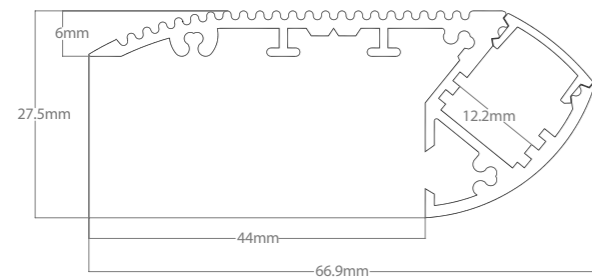

Star11

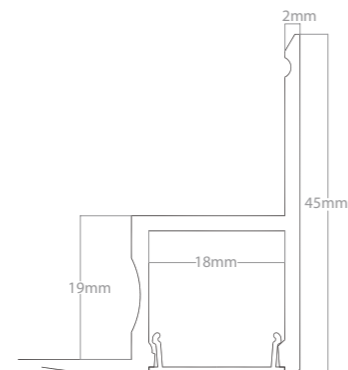

Star12

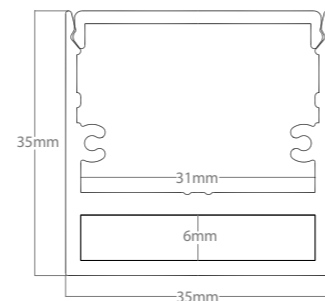

Star14

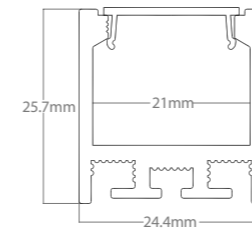

Star15

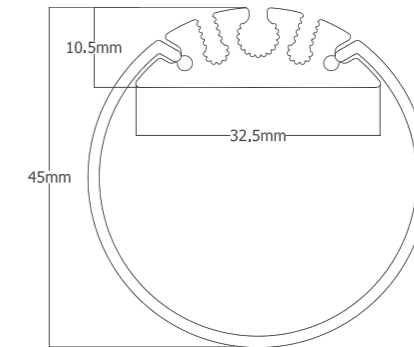

Star16

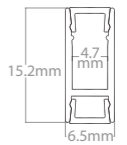

Star17

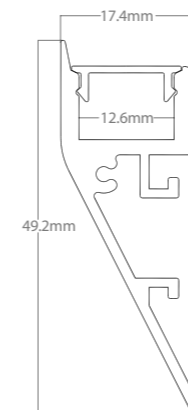

Star18

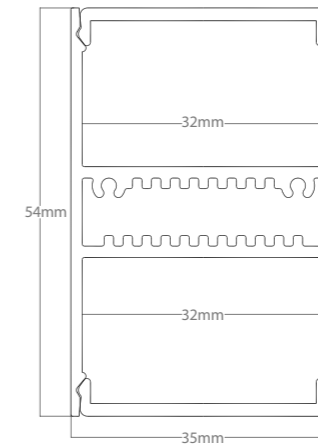

Star19 flex

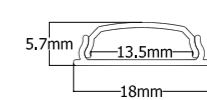

Star20 round

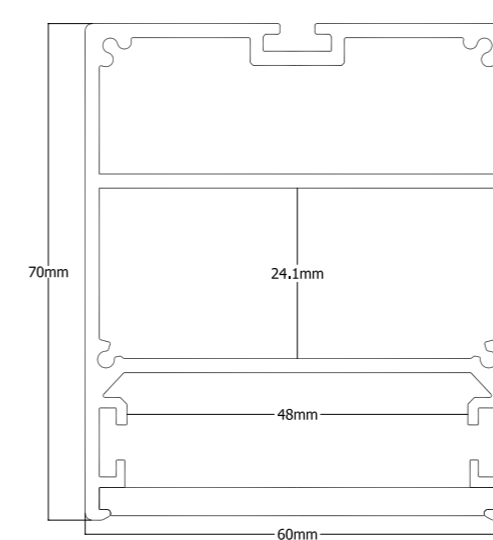

2 Sides

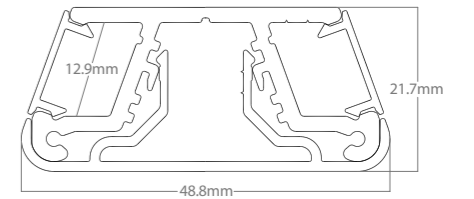

Superficie Surface

Perfiles diseñados para instalaciones en superficie. Personalizable en color, medida y corte a diferentes grados.

Profiles designed to installations on surface. Customizable in color, measurement and cut to different degrees.



Star 0

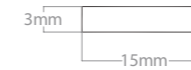

Max. W/m
15 W

Disponible en 6m

2m

AL
6060

			2m	x m
STR-0	Plata mate Matt silver	Perfil superficie sin anodizar Surface profile Not Anodized	5,25 €	2,92 €

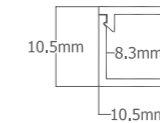

Star 1

Solo para 4,8 W/m Only for 4,8 W/m

Max. W/m
4,8 W

2m

			2m	x m
STR-1	Transparente Clear	Perfil superficie Policarbonato Surface profile Polycarbonate	9,45 €	5,25 €

Star 2

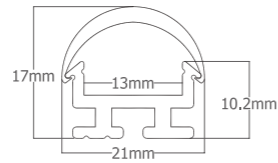

Max. W/m
20 W

Disponibile
en 6m

2m

AL
6060

			2m	x m
STR-2-DM		Perfil superficie con difusor mate Surface profile with medium frosted diffuser	21,32 €	11,84 €
STR-2-DT		Perfil superficie con difusor transparente Surface profile with clear diffuser	20,35 €	11,31 €
STR-2-15		Perfil superficie con óptica 15° mate Surface profile with 15° medium frosted lens	32,45 €	18,03 €
STR-2-30	Plata mate Matt silver	Perfil superficie con óptica 30° mate Surface profile with 30° medium frosted lens	25,73 €	14,29 €
STR-2-60		Perfil superficie con óptica 60° mate Surface profile with 60° medium frosted lens	25,73 €	14,29 €
STR-2-90		Perfil superficie con óptica 90° mate Surface profile with 90° medium frosted lens	25,73 €	14,29 €
STR-2-AS		Perfil superficie con óptica asimétrica mate Surface profile with asymmetrical medium frosted lens	33,60 €	18,67 €
STR-2-A		Perfil superficie sin difusor Surface profile without diffuser	12,50 €	6,94 €
Accesorios Accessories				
STR-2-CL	Transparente Clear	Clip sujeción Mounting bracket	0,79 €	
STR-2-TP	Gris Grey	Tapa final End cup	0,95 €	
DIF-STR2-M	Mate Medium frosted	Difusor para STAR 2 Diffuser to STAR 2	8,82 €	4,90 €
DIF-STR2-T	Transparente Clear	Difusor para STAR 2 Diffuser to STAR 2	7,85 €	4,36 €
DIF-STR2-15		Difusor óptica 15° para STAR 2 15° lens diffuser to STAR 2	19,95 €	11,08 €
DIF-STR2-30		Difusor óptica 30° para STAR 2 30° diffuser to STAR 2	13,23 €	7,35 €
DIF-STR2-60	Mate Medium frosted	Difusor óptica 60° para STAR 2 60° diffuser to STAR 2	13,23 €	7,35 €
DIF-STR2-90		Difusor óptica 90° para STAR 2 90° diffuser to STAR 2	13,23 €	7,35 €
DIF-STR2-AS		Difusor óptica asimétrica para STAR 2 Asymmetric diffuser to STAR 2	21,11 €	11,73 €



STR-2-CL



STR-2-TP



DIF-STR2-15



DIF-STR2-AS



DIF-STR2-30



DIF-STR2-60



DIF-STR2-90

Star 2D

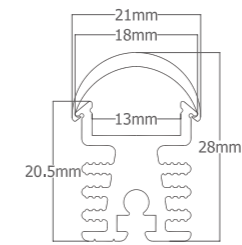

Max. W/m
30 W

Disponibile
en 6m

2m

AL
6060

			2m	x m
STR-2D-DM		Perfil superficie con difusor mate Surface profile with medium frosted diffuser	30,87 €	17,15 €
STR-2D-DT		Perfil superficie con difusor transparente Surface profile with clear diffuser	29,82 €	16,57 €
STR-2D-15		Perfil superficie con óptica 15° mate Surface profile with 15° medium frosted lens	41,96 €	23,31 €
STR-2D-30	Plata mate Matt silver	Perfil superficie con óptica 30° mate Surface profile with 30° medium frosted lens	35,24 €	19,58 €
STR-2D-60		Perfil superficie con óptica 60° mate Surface profile with 60° medium frosted lens	35,24 €	19,58 €
STR-2D-90		Perfil superficie con óptica 90° mate Surface profile with 90° medium frosted lens	35,24 €	19,58 €
STR-2D-AS		Perfil superficie con óptica asimétrica mate Surface profile with asymmetrical medium frosted lens	43,11 €	23,95 €
STR-2D-A		Perfil superficie sin difusor Surface profile without diffuser	23,00 €	12,65 €
Accesorios Accessories				
STR-2D-CL	Transparente Clear	Clip sujeción Mounting bracket	0,79 €	
STR-2D-CLB	Gris Grey	Clip sujeción basculante Swing clamp	3,75 €	
STR-2D-TP	Gris Grey	Tapa final End cup	0,95 €	
DIF-STR2D-M	Mate Medium frosted	Difusor para STAR 2D Diffuser to STAR 2D	8,82 €	4,90 €
DIF-STR2D-T	Transparente Clear	Difusor para STAR 2D Diffuser to STAR 2D	7,85 €	4,36 €
DIF-STR2D-15		Difusor óptica 15° para STAR 2D 15° diffuser to STAR 2D	19,95 €	11,08 €
DIF-STR2D-30		Difusor óptica 30° para STAR 2D 30° diffuser to STAR 2D	13,23 €	7,35 €
DIF-STR2D-60	Mate Medium frosted	Difusor óptica 60° para STAR 2D 60° diffuser to STAR 2D	13,23 €	7,35 €
DIF-STR2D-90		Difusor óptica 90° para STAR 2D 90° diffuser to STAR 2D	13,23 €	7,35 €
DIF-STR2D-AS		Difusor óptica asimétrica para STAR 2D Asymmetric diffuser to STAR 2D	21,11 €	11,73 €



STR-2D-CL



STR-2D-CLB



STR-2D-TP



DIF-STR2D-15



DIF-STR2D-30



DIF-STR2D-60



DIF-STR2D-90



DIF-STR2D-AS

Star 3

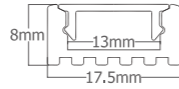

Max. W/m
20 W

Disponible
en 6m

2m

AL
6060

			2m	x m
STR-3-DM		Perfil superficie con difusor mate Surface profile with medium frosted diffuser	17,75 €	9,86 €
STR-3-DO		Perfil superficie con difusor opal Surface profile with frosted diffuser	17,75 €	9,86 €
STR-3-DT	Plata mate Matt silver	Perfil superficie con difusor transparente Surface profile with clear diffuser	14,91 €	8,28 €
STR-3-30		Perfil superficie con óptica 30° Surface profile with 30° lens	24,47 €	13,59 €
STR-3-A		Perfil superficie sin difusor Surface profile without diffuser	11,24 €	6,18 €
STR-3-DM-B		Perfil superficie con difusor mate White surface profile with medium frosted diffuser	23,00 €	12,78 €
STR-3-DO-B		Perfil superficie con difusor opal White surface profile with frosted diffuser	23,00 €	12,78 €
STR-3-DT-B	Blanco White	Perfil superficie con difusor transparente White profile with clear diffuser	20,16 €	11,20 €
STR-3-30-B		Perfil superficie con óptica 30° Surface profile with 30° lens	27,30 €	15,17 €
STR-3-B		Perfil superficie sin difusor Surface profile without diffuser	14,07 €	7,82 €
STR-3-DM-N		Perfil superficie con difusor mate Surface profile with medium frosted diffuser	23,00 €	12,78 €
STR-3-DO-N		Perfil superficie con difusor opal Surface profile with frosted diffuser	23,00 €	12,78 €
STR-3-30-N	Negro Black	Perfil superficie con óptica 30° Surface profile with 30° lens	27,30 €	15,17 €
STR-3-DT-N		Perfil superficie con difusor transparente Black surface profile with clear diffuser	20,16 €	11,20 €
STR-3-N		Perfil superficie sin difusor Black surface profile without diffuser	14,07 €	7,82 €
Accesorios Accessories				
STR-3-TP	Gris Grey	Tapa final End cup	0,82 €	
STR-3-TPT		Tapa final con taladro End cup with cable hole	0,82 €	
STR-3-TP-B	Blanca White	Tapa final End cup	0,98 €	
STR-3-TPT-B		Tapa final con taladro End cup with cable hole	0,98 €	
STR-3-TP-N	Negra Black	Tapa final End cup	0,98 €	
STR-3-TPT-N		Tapa final con taladro End cup with cable hole	0,98 €	
STR-3-CL	Transparente Clear	Clip sujeción Mounting bracket	0,85 €	
DIF-STR3-M	Mate Medium frosted	Difusor para STAR 3 Diffuser to STAR 3	6,01 €	3,34 €
DIF-STR3-O	Opal Frosted	Difusor para STAR 3 Diffuser to STAR 3	6,01 €	3,34 €
DIF-STR3-T	Transparente Clear	Difusor para STAR 3 Diffuser to STAR 3	4,33 €	2,40 €
DIF-STR3-30	Transparente Clear	Difusor óptica 30° para STAR 3 30° lens diffuser to STAR 3	13,23 €	7,35 €



STR-3-TP



STR-3-TPT



STR-3-CL



DIF-STR3-30

Star 4

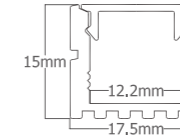

Max. W/m
20 W

Disponible
en 6m

2m

AL
6060

			2m	x m
STR-4-DM		Perfil superficie con difusor mate Surface profile with medium frosted diffuser	20,95 €	11,64 €
STR-4-DO		Perfil superficie con difusor opal Surface profile with frosted diffuser	20,95 €	11,64 €
STR-4-DT	Plata mate Matt silver	Perfil superficie con difusor transparente Surface profile with clear diffuser	18,53 €	10,30 €
STR-4-30		Perfil superficie con óptica 30° Surface profile with 30° lens	28,09 €	15,61 €
STR-4-A		Perfil superficie sin difusor Surface profile without diffuser	14,86 €	9,60 €
STR-4-DM-B		Perfil superficie con difusor mate Surface profile with medium frosted diffuser	26,20 €	14,55 €
STR-4-DO-B		Perfil superficie con difusor opal Surface profile with frosted diffuser	26,20 €	14,55 €
STR-4-DT-B	Blanco White	Perfil superficie con difusor transparente Surface profile with clear diffuser	24,83 €	13,80 €
STR-4-30-B		Perfil superficie con óptica 30° Surface profile with 30° lens	30,50 €	16,95 €
STR-4-B		Perfil superficie sin difusor Surface profile without diffuser	17,27 €	9,60 €
STR-4-DM-N		Perfil superficie con difusor mate Surface profile with medium frosted diffuser	26,20 €	14,55 €
STR-4-DO-N		Perfil superficie con difusor opal Surface profile with frosted diffuser	26,20 €	14,55 €
STR-4-DT-N	Negro Black	Perfil superficie con difusor transparente Surface profile with clear diffuser	24,83 €	13,80 €
STR-4-30-N		Perfil superficie con óptica 30° Surface profile with 30° lens	30,50 €	16,95 €
STR-4-N		Perfil superficie sin difusor Surface profile without diffuser	17,27 €	8,25 €
Accesorios Accessories				
STR-4-TP	Gris Grey	Tapa final End cup	0,88 €	
STR-4-TPT		Tapa final con taladro End cup with cable hole	0,88 €	
STR-4-TP-B	Blanca White	Tapa final End cup	1,05 €	
STR-4-TPT-B		Tapa final con taladro End cup with cable hole	1,05 €	
STR-4-TP-N	Negra Black	Tapa final End cup	1,05 €	
STR-4-TPT-N		Tapa final con taladro End cup with cable hole	1,05 €	
STR-4-CL	Transparente Clear	Clip sujeción Mounting bracket	0,85 €	
DIF-STR4-M	Mate Medium frosted	Difusor para STAR 4 Diffuser to STAR 4	6,01 €	3,34 €
DIF-STR4-O	Opal Frosted	Difusor para STAR 4 Diffuser to STAR 4	6,01 €	3,34 €
DIF-STR4-T	Transparente Clear	Difusor para STAR 4 Diffuser to STAR 4	4,33 €	2,40 €
DIF-STR4-30	Transparente Clear	Difusor óptica 30° para STAR 4 30° lens diffuser to STAR 4	13,23 €	7,35 €



STR-4-TP



STR-4-TPT



STR-4-CL



DIF-STR4-30

Star 6

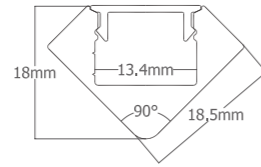

Max. W/m
37 W

Disponibile
en 6m

2m

AL
6060

			2m	x m
STR-6-DM		Perfil superficie con difusor mate Surface profile with medium frosted diffuser	25,73 €	14,29 €
STR-6-DO		Perfil superficie con difusor opal Surface profile with frosted diffuser	25,73 €	14,29 €
STR-6-DT	Plata mate Matt silver	Perfil superficie con difusor transparente Surface profile with clear diffuser	24,52 €	13,62 €
STR-6-30-N		Perfil superficie con óptica 30° Surface profile with 30° lens	34,07 €	18,93 €
STR-6-A		Perfil superficie sin difusor Surface profile without diffuser	20,84 €	12,25 €
STR-6-DM-B		Perfil superficie con difusor mate Surface profile with medium frosted diffuser	30,98 €	17,21 €
STR-6-DO-B		Perfil superficie con difusor opal Surface profile with frosted diffuser	30,98 €	17,21 €
STR-6-DT-B	Blanco White	Perfil superficie con difusor transparente Surface profile with clear diffuser	29,77 €	16,54 €
STR-6-30-B		Perfil superficie con óptica 30° Surface profile with 30° lens	35,28 €	19,60 €
STR-6-B		Perfil superficie sin difusor Surface profile without diffuser	22,05 €	12,25 €
STR-6-DM-N		Perfil superficie con difusor mate Surface profile with medium frosted diffuser	30,98 €	17,21 €
STR-6-DO-N		Perfil superficie con difusor opal Surface profile with frosted diffuser	30,98 €	17,21 €
STR-6-DT-N	Negro Black	Perfil superficie con difusor transparente Surface profile with clear diffuser	29,77 €	16,54 €
STR-6-30-N		Perfil superficie con óptica 30° Surface profile with 30° lens	35,28 €	19,60 €
STR-6-N		Perfil superficie sin difusor Surface profile without diffuser	22,05 €	12,25 €
Accesorios Accessories				
STR-6-TP	Gris Grey	Tapa final End cup	0,88 €	
STR-6-TP-B	Blanca White	Tapa final End cup	1,05 €	
STR-6-TP-N	Negra Black	Tapa final End cup	1,05 €	
STR-6-CL	Transparente Clear	Clip sujeción Mounting bracket	1,10 €	
DIF-STR6-M	Mate Medium frosted	Difusor para STAR 6 Diffuser to STAR 6	6,01 €	3,34 €
DIF-STR6-O	Opal Frosted	Difusor para STAR 6 Diffuser to STAR 6	6,01 €	3,34 €
DIF-STR6-T	Transparente Clear	Difusor para STAR 6 Diffuser to STAR 6	4,33 €	2,40 €
DIF-STR6-30	Transparente Clear	Difusor óptica 30° para STAR 6 30° lens diffuser to STAR 6	13,23 €	7,35 €



STR-6-TP



STR-6-CL



DIF-STR-6-30

Star 7

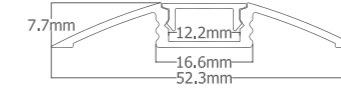

Max. W/m
20 W

2m

AL
6060

			2m	x m
STR-7-DM	Plata mate Matt silver	Perfil superficie con difusor mate Surface profile with medium frosted diffuser	69,51 €	38,23 €
STR-7-DT		Perfil superficie con difusor transparente Surface profile with clear diffuser	67,83 €	37,68 €
Accesorios Accessories				
STR-7-TP	Gris Grey	Tapa final End cup	5,04 €	
DIF-STR7-M	Mate Medium frosted	Difusor para STAR 7 Diffuser to STAR 7	6,01 €	3,34 €
DIF-STR7-T	Transparente Clear	Difusor para STAR 7 Diffuser to STAR 7	4,33 €	2,40 €



STR-7-TP

Star 9

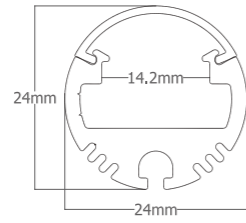

Max. W/m
37 W

Disponible
en 6m

2m

AL
6060

			2m	x m
STR-9-DM	Plata mate Matt silver	Perfil superficie con difusor mate Surface profile with medium frosted diffuser	44,10 €	24,50 €
STR-9-DT		Perfil superficie con difusor transparente Surface profile with clear diffuser	42,89 €	23,83 €
STR-9-DM-B	Blanco White	Perfil superficie con difusor mate Surface profile with medium frosted diffuser	49,35 €	27,42 €
STR-9-DT-B		Perfil superficie con difusor transparente Surface profile with clear diffuser	49,35 €	27,42 €
STR-9-DM-N	Negro Black	Perfil superficie con difusor mate Surface profile with medium frosted diffuser	49,35 €	27,42 €
STR-9-DT-N		Perfil superficie con difusor transparente Surface profile with clear diffuser	49,35 €	27,42 €
Accesorios Accessories				
STR-9-TP	Gris Grey	Tapa final End cup	1,10 €	
STR-9-TP-B	Blanca White	Tapa final End cup	1,30 €	
STR-9-TP-N	Negra Black	Tapa final End cup	1,30 €	
STR-9-CLM	Plata mate Matt silver	SopORTE pared (forma t) Middle support (T shape)	21,00 €	
STR-9-BR		SopORTE pared (brazo) Wall support (arm)	16,50 €	
STR-9-BASC	Gris Grey	SopORTE basculante PVC Tilt Support	5,00 €	
STR-9-SP		SopORTE pared PVC Wall support	9,90 €	
DIF-STR9-M	Mate Medium frosted	Difusor para STAR 9 Diffuser to STAR 9	7,06 €	3,92 €
DIF-STR9-T	Transparente Clear	Difusor para STAR 9 Diffuser to STAR 9	6,95 €	3,86 €



STR-9-TP



STR-9-BR



STR-9-CLM



STR-9-BASC



STR-9-SP

Star 10

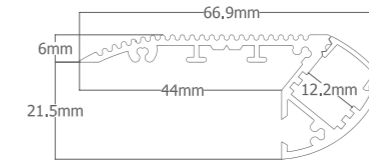

Max. W/m
30 W

2m

AL
6060

			2m	x m
STR-10-DM	Plata mate Matt silver	Perfil superficie con difusor mate Surface profile with medium frosted diffuser	140,70 €	78,17 €
Accesorios Accessories				
STR-10-TPD	Gris Grey	Tapa final derecha Right end cup	8,00 €	
STR-10-TPI		Tapa final izquierda Left end cup	8,00 €	
DIF-STR10-M	Mate Medium frosted	Difusor para STAR 10 Diffuser to STAR 10	6,01 €	3,34 €



STR-10-TP



Star 11

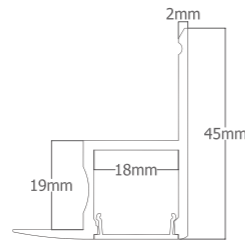

Max. W/m
45 W

Disponible
en 6m

2m

AL
6060

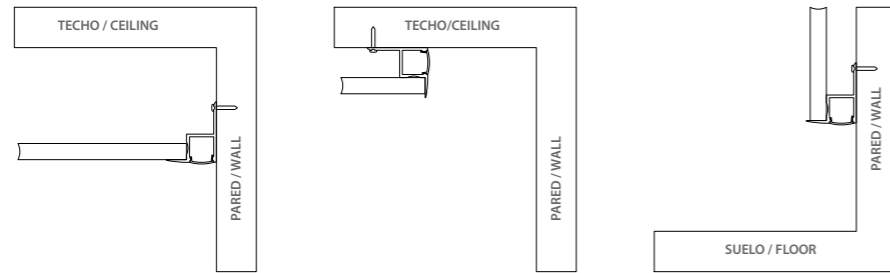

			2m	x m
STR-11-DO	Plata mate Matt silver	Perfil superficie con difusor opal Surface profile with frosted diffuser	64,26 €	35,70 €
Accesorios Accessories				
DIF-STR11-O	Opal Frosted	Difusor para Star 11 Diffuser to STAR 11	6,34 €	3,52 €

Star 12

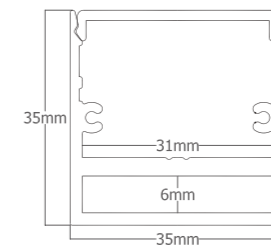

Max. W/m
60 W

Disponible
en 6m

2m

AL
6060

			2m	x m
STR-12-DM		Perfil superficie con difusor mate Surface profile with medium frosted diffuser	49,88 €	27,71 €
STR-12-DT	Plata mate Matt silver	Perfil superficie con difusor transparente Surface profile with clear diffuser	52,17 €	28,98 €
STR-12-A		Perfil superficie sin difusor Surface profile without diffuser	39,80 €	22,11 €
STR-12-DM-B		Perfil superficie con difusor mate Surface profile with medium frosted diffuser	55,13 €	30,63 €
STR-12-DT-B	Blanco White	Perfil superficie con difusor transparente Surface profile with clear diffuser	53,03 €	29,46 €
STR-12-B		Perfil superficie sin difusor Surface profile without diffuser	45,05 €	25,03 €
STR-12-DM-N		Perfil superficie con difusor mate Surface profile with medium frosted diffuser	55,13 €	30,63 €
STR-12-DT-N	Negra Black	Perfil superficie con difusor transparente Surface profile with clear diffuser	53,03 €	29,46 €
STR-12-N		Perfil superficie sin difusor Surface profile without diffuser	45,05 €	25,03 €
Accesorios Accessories				
STR-12-TP	Gris Grey	Tapa final aluminio Aluminium end cup	8,50 €	
STR-12-TP-B	Blanca White	Tapa final aluminio Aluminium end cup	9,00 €	
STR-12-TP-N	Negra Black	Tapa final aluminio Aluminium end cup	9,00 €	
STR-12-U		Pieza unión Connecting piece	5,90 €	
STR-12-E	Plata mate Matt silver	Pieza unión a 90° 90° connecting piece	7,80 €	29,46 €
STR-12-PS		Pieza de sujeción Fixing piece	9,22 €	
DIF-STR12-M	Mate Medium frosted	Difusor para STAR 12 Diffuser to STAR 12	13,17 €	7,32 €
DIF-STR12-T	Transparente Clear	Difusor para STAR 12 Diffuser to STAR 12	12,37 €	6,87 €



STR-12-TP



STR-12-U



STR-12-E



STR-12-PS

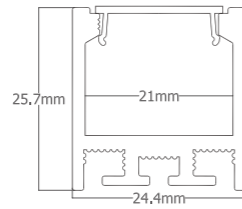

Star 14

Max. W/m
45 W

Disponible
en 6m

2m

AL
6060

			2m	x m
STR-14-DO		Perfil superficie con difusor opal Surface profile with frosted diffuser	32,81 €	18,23 €
STR-14-DT	Plata mate Matt silver	Perfil superficie con difusor transparente Surface profile with clear diffuser	31,97 €	17,76 €
STR-14-A		Perfil superficie sin difusor Surface profile without diffuser	26,09 €	14,50 €
STR-14-DO-B		Perfil superficie con difusor opal Surface profile with frosted diffuser	38,01 €	20,91 €
STR-14-DT-B	Blanco White	Perfil superficie con difusor transparente Surface profile with clear diffuser	37,59 €	20,88 €
STR-14-B		Perfil superficie sin difusor Surface profile without diffuser	31,71 €	17,62 €
STR-14-DO-N		Perfil superficie con difusor opal Surface profile with frosted diffuser	38,01 €	20,91 €
STR-14-DT-N	Negro Black	Perfil superficie con difusor transparente Surface profile with clear diffuser	37,59 €	20,88 €
STR-14-N		Perfil superficie sin difusor Surface profile without diffuser	31,71 €	17,62 €
Accesorios Accessories				
STR-14-TP	Gris Grey	Tapa final End cup	1,25 €	
STR-14-TP-B	Blanca White	Tapa final End cup	1,40 €	
STR-14-TP-N	Negra Black	Tapa final End cup	1,40 €	
STR-14-CL	Transparente Clear	Clip sujeción Mounting bracket	0,79 €	
ACC-STR14-90		Pieza unión a 90° con difusor mate 90° connecting piece with frosted diffuser	57,00 €	
ACC-STR14-90-IN		Pieza unión a 90° con difusor mate, iluminación interior 90° connecting piece with frosted diffuser, inside lighting	57,00 €	
ACC-STR14-90-OUT		Pieza unión a 90° con difusor mate, iluminación exterior 90° connecting piece with frosted diffuser, outside lighting	57,00 €	
ACC-STR14-135		Pieza unión a 135° con difusor mate 135° connecting piece with frosted diffuser	57,00 €	
ACC-STR14-135-IN		Pieza unión a 135° con difusor mate, iluminación interior 135° connecting piece with frosted diffuser, inside lighting	57,00 €	
ACC-STR14-135-OUT		Pieza unión a 135° con difusor mate, iluminación exterior 135° connecting piece with frosted diffuser, outside lighting	57,00 €	
ACC-STR14-T	Plata mate Matt silver	Pieza unión a 90° con difusor mate, en forma de T Connecting piece with frosted diffuser, T shape	89,80 €	
ACC-STR14-T135-I		Pieza unión a 135° con difusor mate, en forma de T (izquierda) 135° connecting piece with frosted diffuser T shape (left)	89,80 €	
ACC-STR14-T135-D		Pieza unión a 135° con difusor mate, en forma de T (derecha) 135° connecting piece with frosted diffuser, T shape (right)	89,80 €	
ACC-STR14-X		Pieza unión a 90° con difusor mate, en forma de X 90° connecting piece with frosted diffuser, X shape	68,00 €	
ACC-STR14-X135		Pieza unión a 135° con difusor mate, en forma de X 135° connecting piece with frosted diffuser, X shape	95,00 €	
STR-14-U		Pieza unión Connecting piece	2,20 €	
STR-14-PS		Pieza de sujeción Fixing piece	8,50 €	
DIF-STR14-O	Opal Frosted	Difusor para STAR 14 Diffuser to STAR 14	6,34 €	3,52 €
DIF-STR14-T	Transparente Clear	Difusor para STAR 14 Diffuser to STAR 14	5,88 €	3,27 €

Accesorios disponibles con difusor transparente
Accessories available with transparent diffuser

Accesorios Star 14 Accessories Star 14



STR-14-TP



STR-14-CL



STR-14-U



STR-14-PS



ACC-STR14-90



ACC-STR14-90-IN



ACC-STR14-90-OUT



ACC-STR14-135



ACC-STR14-135-IN



ACC-STR14-135-OUT



ACC-STR14-T



ACC-STR14-T135-I



ACC-STR14-T135-D



ACC-STR14-X



ACC-STR14-X135

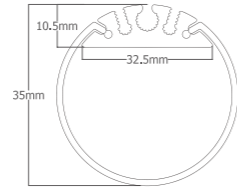

Star 15

Max. W/m
30 W

Disponible
en 6m

2m

AL
6060

			2m	x m
STR-15-DO	Plata mate Matt silver	Perfil superficie con difusor circular Surface profile with circular frosted	67,73 €	37,63 €
STR-15-A		Perfil superficie sin difusor Surface profile without diffuser	18,06 €	10,03 €
STR-15-DO-B	Blanco White	Perfil superficie con difusor circular Surface profile with circular frosted	72,98 €	40,54 €
STR-15-B		Perfil superficie sin difusor Surface profile without diffuser	22,26 €	12,37 €
STR-15-DO-N	Negro Black	Perfil superficie con difusor circular Surface profile with circular frosted	72,98 €	40,54 €
STR-15-N		Perfil superficie sin difusor Surface profile without diffuser	22,26 €	12,37 €
Accesorios Accessories				
STR-15-TP	Mate Medium frosted	Tapa final End cup	6,87 €	
IO	Plata mate Matt silver	Cable tensor con regulador de altura Tensioning cable with height regulator	6,84 €	
KIT-SB	Plata mate Matt silver	2 cables tensores con cable de alimentación y regulador de altura 2 tensioning cables with power cable and height regulator	53,92 €	
DIF-STR15-O	Opal Frosted	Difusor para STAR 15 Diffuser to STAR 15	49,67 €	27,59 €



STR-15-TP



IO



KIT-SB

Max. 100W

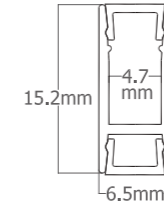

Star 16

Solo para MINI-LED Only for MINI-LED

Max. W/m
10 W

Disponible
en 4m

2m

AL
6060

			2m	x m
STR-16-DO	Plata mate Matt silver	Perfil superficie con difusor opal con pieza sujeción Surface profile with frosted diffuser and fixing piece	24,10 €	13,39 €
STR-16-A		Perfil superficie con pieza sujeción, sin difusor Surface profile with frosted diffuser without fixing piece	18,06 €	10,03 €
STR-16-DO-B	Blanco White	Perfil superficie con difusor opal y pieza sujeción Surface profile with frosted diffuser and fixing piece	26,51 €	14,73 €
STR-16-B		Perfil superficie con pieza sujeción Surface profile with fixing piece	19,87 €	11,04 €
STR-16-DO-N	Negro Black	Perfil superficie con difusor opal y pieza sujeción Surface profile with frosted diffuser and fixing piece	26,51 €	14,73 €
STR-16-N		Perfil superficie con pieza sujeción Surface profile with fixing piece	19,87 €	11,04 €
Accesorios Accessories				
STR-16-TP	Gris Grey	Tapa final End cup	1,50 €	
STR-16-TP-B	Blanco White	Tapa final End cup	1,65 €	
STR-16-TP-N	Negro Black	Tapa final End cup	1,65 €	
DIF-STR16-O	Opal Frosted	Difusor opal / Pieza de fijación para STAR 16 Diffuser / Fixing piece to STAR 16	5,75 €	3,19 €



STR-16-TP



DIF-STR-16-O

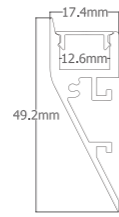

Star 17

Max. W/m
20 W

Disponible
en 6m

2m

AL
6060

			2m	x m
STR-17-DT		Perfil superficie con difusor transparente Surface profile with clear diffuser	24,83 €	13,80 €
STR-17-30	Plata mate Matt silver	Perfil superficie con óptica 30° Surface profile with 30° lens	35,60 €	19,78 €
STR-17-A		Perfil superficie sin difusor Surface profile without diffuser	22,37 €	12,43 €
STR-17-DT-B		Perfil superficie con difusor transparente Surface profile with clear diffuser	30,08 €	16,71 €
STR-17-30-B	Blanco White	Perfil superficie con óptica 30° Surface profile with 30° lens	39,60 €	22,00 €
STR-17-B		Perfil superficie sin difusor Surface profile without diffuser	26,37 €	14,50 €
STR-17-DT-N		Perfil superficie con difusor transparente Surface profile with clear diffuser	37,92 €	20,86 €
STR-17-30-N	Negro Black	Perfil superficie con óptica 30° Surface profile with 30° lens	39,60 €	22,00 €
STR-17-N		Perfil superficie sin difusor Surface profile without diffuser	26,37 €	14,50 €
Accesorios Accessories				
STR-17-TP-D	Gris Grey	Tapa final derecha Right end cup	2,20 €	
STR-17-TP-I		Tapa final izquierda Left end cup	2,20 €	
STR-17-TP-D-B	Blanca White	Tapa final derecha Right end cup	2,30 €	
STR-17-TP-I-B		Tapa final izquierda Left end cup	2,30 €	
STR-17-TP-D-N	Negra Black	Tapa final derecha Right end cup	2,30 €	
STR-17-TP-I-N		Tapa final izquierda Left end cup	2,30 €	
STR-17-CL	Transparente Clear	Clip sujeción Mounting bracket	0,79 €	
DIF-STR17-O	Opal Frosted	Difusor para STAR 17 Diffuser to STAR 17	6,01 €	3,34 €
DIF-STR17-T	Transparente Clear	Difusor para STAR 17 Diffuser to STAR 17	4,33 €	2,40 €
DIF-STR17-30	Transparente Clear	Difusor óptica 30° para STAR 17 30° lens diffuser to STAR 17	13,23 €	7,35 €



STR-17-TP-D



STR-17-TP-I



STR-17-CL



DIF-STR17-30

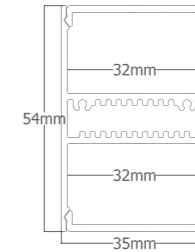

Star 18

Max. W/m
90 W

Disponible
en 6m

2m

AL
6060



			2m	x m
STR-18-DM		Perfil superficie con difusores mate Surface profile with medium frosted diffuser	82,94 €	46,08 €
STR-18-DT	Plata mate Matt silver	Perfil superficie con difusores transparente Surface profile with clear diffuser	81,34 €	45,19 €
STR-18-DMT		Perfil superficie con difusores mate y transparente Surface profile with medium frosted and clear diffuser	80,54 €	44,74 €
STR-18-A		Perfil superficie sin difusor Surface profile without diffuser	55,00 €	30,56 €
STR-18-DM-B		Perfil superficie con difusores mate Surface profile with medium frosted diffuser	89,34 €	49,63 €
STR-18-DT-B	Blanco White	Perfil superficie con difusores transparente Surface profile with clear diffuser	87,74 €	48,74 €
STR-18-DMT-B		Perfil superficie con difusores mate y transparente Surface profile with medium frosted and clear diffuser	88,54 €	49,19 €
STR-18-B		Perfil superficie sin difusor Surface profile without diffuser	63,00 €	35,00 €
STR-18-DM-N		Perfil superficie con difusores mate Surface profile with medium frosted diffuser	89,34 €	49,63 €
STR-18-DT-N	Negro Black	Perfil superficie con difusores transparente Surface profile with clear diffuser	87,74 €	48,74 €
STR-18-DMT-N		Perfil superficie con difusores mate y transparente Surface profile with medium frosted and clear diffuser	88,54 €	49,19 €
STR-18-N		Perfil superficie sin difusor Surface profile without diffuser	63,00 €	35,00 €
Accesorios Accessories				
STR-18-TP	Gris Grey	Tapa final End cup	12,50 €	
STR-18-TP-B	Blanco White	Tapa final End cup	13,80 €	
STR-18-TP-N	Negra Black	Tapa final End cup	13,80 €	
STR-18-U	Plata mate Matt silver	Pieza unión Connecting piece	8,10 €	
STR-18-E		Pieza unión a 90° 90° connecting piece	9,50 €	
DIF-STR18-M	Mate Medium frosted	Difusor para STAR 18 Diffuser to STAR 18	26,34 €	14,63 €
DIF-STR18-T	Transparente Clear	Difusor para STAR 18 Diffuser to STAR 18	24,74 €	13,74 €



STR-18-TP



STR-18-U



STR-18-E

Star 19 flex

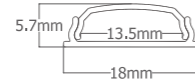

Max. W/m
15 W

Disponible
en 6m

2m

AL
6060

			2m	x m
STR-19-DO	Plata mate Matt silver	Perfil superficie con difusor opal Surface profile with frosted diffuser	16,13 €	8,87 €
STR-19-TP	Gris Grey	Tapa final End cup	1,05 €	
STR-19-TPT	Gris Grey	Tapa final con taladro End cup with cable hole	1,05 €	
STR-19-CL	Acero inoxidable Stainless Steel	Clip sujeción Mounting bracket	0,55 €	
STR-19-U	Plata mate Matt silver	Pieza unión Connecting piece	2,10 €	
DIF-STR19-O	Opal Frosted	Difusor para STAR 19 Diffuser to STAR 19	3,44 €	1,90 €



STR-19-TP

STR-19-TPT

STR-19-CL

STR-19-U



Star 20 round

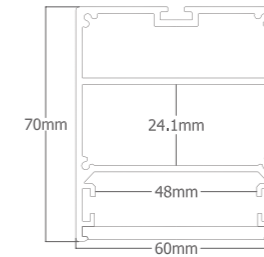

Max. W/m
60 W

Disponible
en 6m

2m

AL
6060

			2m	x m
STR-20-1/4-1		Perfil 1/4 círculo de 1m con difusor mate Profile 1/4 circle of 1m with frosted diffuser	a consultar	to consult
STR-20-1/4-2	Plata mate Matt silver	Perfil 1/4 círculo de 2m con difusor mate Profile 1/4 circle of 2m with frosted diffuser	a consultar	to consult
STR-20-1/4-3		Perfil 1/4 círculo de 3m con difusor mate Profile 1/4 circle of 3m with frosted diffuser	a consultar	to consult
STR-20-DM	Plata mate Matt silver	Perfil superficie con difusor mate Surface profile with medium frosted diffuser	a consultar	to consult
STR-20-TP	Gris Grey	Tapa final End cup	a consultar	to consult
STR-20-U	Plata mate Matt silver	Pieza unión Connecting piece	a consultar	to consult
STR-20-IO		Cable tensor con regulador de altura Tensioning cable with height regulator	a consultar	to consult
DIF-STR20-M	Plata mate Matt silver	Difusor para STAR 20 Diffuser to STAR 20	a consultar	to consult
DIF-STR20-25M		25m, Difusor para STAR 20 25m, Diffuser to STAR 20	a consultar	to consult



Star 20 round



STR-20-1/4-1
STR-20-1/4-2
STR-20-1/4-3



STR-20-DM

Accesorios Accessories

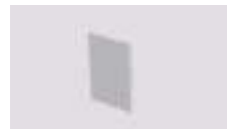

STR-20-TP



STR-20-U



STR-20-IO



DIF-STR20-M

Configuración Configuration

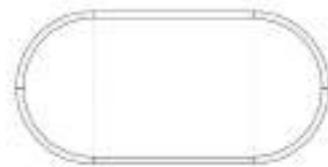
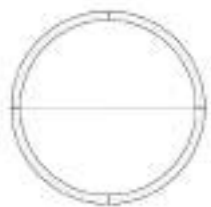

Star 20 round

Ejemplos Examples



2 Sides



Diseñado por Fluye Designed by Fluye

Perfil de diseño minimalista para uso interior con gran versatilidad funcional y estética.
Minimalist design profile for interior use with great functional and versatility aesthetics.



2 Sides

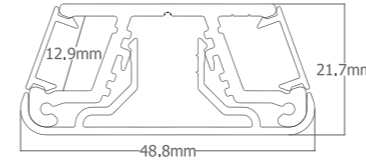

Max. W/m
30 W

Disponibile
en 6m

2m

up&down

AL
6060

			2m	x m
STR-TS-DM		Perfil superficie con difusores mate Surface profile with medium frosted diffuser	84,83 €	47,13 €
STR-TS-DO	Plata mate Matt silver	Perfil superficie con difusores opal Surface profile with frosted diffuser	84,83 €	47,13 €
STR-TS-DT		Perfil superficie con difusores transparente Surface profile with clear diffuser	80,56 €	44,30 €
STR-TS-DM-B		Perfil superficie con difusores mate Surface profile with medium frosted diffuser	88,96 €	48,93 €
STR-TS-DO-B	Blanco White	Perfil superficie con difusores opal Surface profile with frosted diffuser	88,96 €	48,93 €
STR-TS-DT-B		Perfil superficie con difusores transparente Surface profile with clear diffuser	85,80 €	47,20 €
STR-TS-DM-N		Perfil superficie con difusores mate Surface profile with medium frosted diffuser	88,96 €	48,93 €
STR-TS-DO-N	Negro Black	Perfil superficie con difusores opal Surface profile with frosted diffuser	88,96 €	48,93 €
STR-TS-DT-N		Perfil superficie con difusores transparente Surface profile with clear diffuser	85,80 €	47,20 €
Accesorios Accessories				
STR-TS-TP	Gris Grey	Tapa final End cup	6,82 €	
STR-TS-TP-B	Blanca White	Tapa final End cup	8,29 €	
STR-TS-TP-N	Negra Black	Tapa final End cup	8,29 €	
DIF-STRTS-M	Mate Medium frosted	Difusor para 2 SIDES Diffuser to 2 SIDES	6,00 €	3,33 €
DIF-STRTS-O	Opal Frosted	Difusor para 2 SIDES Diffuser to 2 SIDES	6,00 €	3,33 €
DIF-STRTS-T	Transparente Clear	Difusor para 2 SIDES Diffuser to 2 SIDES	4,33 €	2,41 €



STR-TS-TP

Índice de Perfiles Empotrables Recessed Profiles index

Escala 1:1
Scale 1:1

Star 50

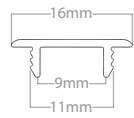

Star 51

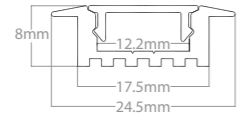

Star 52

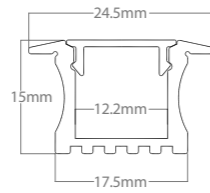

Star 54

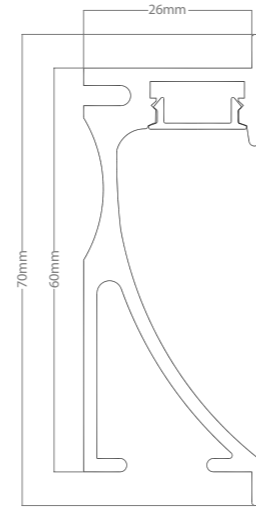

Star 55

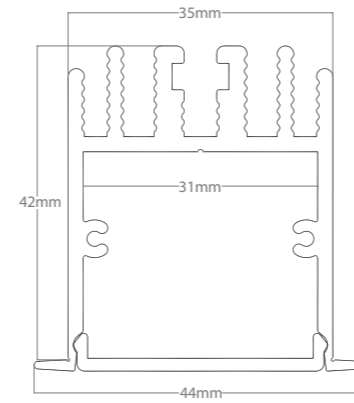

Star 56

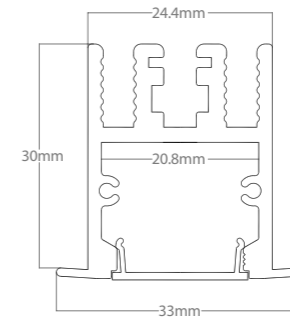

Empotrables Recessed

Perfiles diseñados para instalaciones donde tiene que ir empotrados. Personalizable en color, medida y corte a diferentes grados.

Profiles designed for installations where it has to be recessed. Customizable in color, measurement and cut to different degrees.



Empotrable

Star 50	105
Star 51	106
Star 52	107
Star 54	108
Star 55	109
Star 56	110

Empotrable Recessed

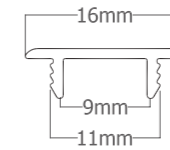

Star 50

3m

STR-50

Mate
Frosted

Perfil empotrable Policarbonato
Recessed profile Polycarbonate

3m

20,15 €



Museu de les Cultures del Mon de Barcelona / Hazluz17

Star 51

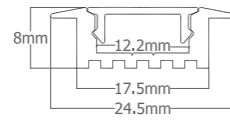

Max. W/m
20 W

Disponibile
en 6m

2m

AL
6060

			2m	x m
STR-51-DM		Perfil empotrable con difusor mate Recessed profile with medium frosted diffuser	18,17 €	10,09 €
STR-51-DO		Perfil empotrable con difusor opal Recessed profile with frosted diffuser	18,17 €	10,09 €
STR-51-DT	Plata mate Matt silver	Perfil empotrable con difusor transparente Recessed profile with clear diffuser	15,33 €	8,52 €
STR-51-30		Perfil empotrable con óptica 30° Recessed profile with 30° lens	24,89 €	13,83 €
STR-51-A		Perfil empotrable sin difusor Recessed profile without diffuser	11,66 €	6,45 €
STR-51-DM-B		Perfil empotrable con difusor mate Recessed profile with medium frosted diffuser	23,42 €	13,01 €
STR-51-DO-B		Perfil empotrable con difusor opal Recessed profile with frosted diffuser	23,42 €	13,01 €
STR-51-DT-B	Blanco White	Perfil empotrable con óptica 30° Recessed profile with 30° lens	20,58 €	11,43 €
STR-51-30-B		Perfil empotrable con difusor transparente Recessed profile with clear diffuser	27,72 €	15,40 €
STR-51-B		Perfil empotrable sin difusor Recessed profile without diffuser	14,49 €	8,05 €
STR-51-DM-N		Perfil empotrable con difusor mate Recessed profile with medium frosted diffuser	23,42 €	13,01 €
STR-51-DO-N		Perfil empotrable con difusor opal Recessed profile with frosted diffuser	23,42 €	13,01 €
STR-51-DT-N	Negro Black	Perfil empotrable con difusor transparente Recessed profile with clear diffuser	20,58 €	11,43 €
STR-51-30-N		Perfil empotrable con óptica 30° Recessed profile with 30° lens	27,72 €	15,40 €
STR-51-N		Perfil empotrable sin difusor Recessed profile without diffuser	14,49 €	8,05 €
Accesorios Accessories				
STR-51-TPT	Gris Grey	Tapa final con taladro End cup with cable hole	0,88 €	
STR-51-TPT-B	Blanca White	Tapa final con taladro End cup with cable hole	1,00 €	
STR-51-TPT-N	Negra Black	Tapa final con taladro End cup with cable hole	1,00 €	
DIF-STR51-M	Mate Medium frosted	Difusor para STAR 51 Diffuser to STAR 51	6,01 €	3,34 €
DIF-STR51-O	Opal Frosted	Difusor para STAR 51 Diffuser to STAR 51	6,01 €	3,34 €
DIF-STR51-T	Transparente Clear	Difusor para STAR 51 Diffuser to STAR 51	4,33 €	2,40 €
DIF-STR51-30	Transparente Clear	Difusor óptica 30° para STAR 51 30° lens diffuser to STAR 51	13,23 €	7,35 €



STR-51-TPT



DIF-STR-51-30

Star 52

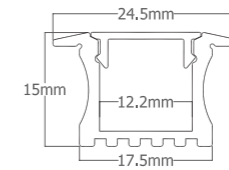

Max. W/m
20 W

Disponibile
en 6m

2m

AL
6060

			2m	x m
STR-52-DM		Perfil empotrable con difusor mate Recessed profile with medium frosted diffuser	21,37 €	11,87 €
STR-52-DO		Perfil empotrable con difusor opal Recessed profile with frosted diffuser	21,37 €	11,87 €
STR-52-DT	Plata mate Matt silver	Perfil empotrable con difusor transparente Recessed profile with clear diffuser	18,95 €	10,53 €
STR-52-30		Perfil empotrable con óptica 30° Recessed profile with 30° lens	28,51 €	15,84 €
STR-52-A		Perfil empotrable sin difusor Recessed profile without diffuser	15,28 €	8,40 €
STR-52-DM-B		Perfil empotrable con difusor mate Recessed profile with medium frosted diffuser	26,62 €	14,79 €
STR-52-DO-B		Perfil empotrable con difusor opal Recessed profile with frosted diffuser	26,62 €	14,79 €
STR-52-DT-B	Blanco White	Perfil empotrable con difusor transparente Recessed profile with clear diffuser	25,25 €	14,03 €
STR-52-30-B		Perfil empotrable con óptica 30° Recessed profile with 30° lens	30,92 €	17,18 €
STR-52-B		Perfil empotrable sin difusor Recessed profile without diffuser	17,69 €	9,83 €
STR-52-DM-N		Perfil empotrable con difusor mate Recessed profile with medium frosted diffuser	26,62 €	14,79 €
STR-52-DO-N		Perfil empotrable con difusor opal Recessed profile with frosted diffuser	26,62 €	14,79 €
STR-52-DT-N	Negro Black	Perfil empotrable con difusor transparente Recessed profile with clear diffuser	25,25 €	14,03 €
STR-52-30-N		Perfil empotrable con óptica 30° Recessed profile with 30° lens	30,92 €	17,18 €
STR-52-N		Perfil empotrable sin difusor Recessed profile without diffuser	17,69 €	9,83 €
Accesorios Accessories				
STR-52-TPT	Gris Grey	Tapa final con taladro End cup with cable hole	0,88 €	
STR-52-TPT-B	Blanca White	Tapa final con taladro End cup with cable hole	1,05 €	
STR-52-TPT-N	Negra Black	Tapa final con taladro End cup with cable hole	1,05 €	
DIF-STR52-M	Mate Medium frosted	Difusor para STAR 52 Diffuser to STAR 52	6,01 €	3,34 €
DIF-STR52-O	Opal Frosted	Difusor para STAR 52 Diffuser to STAR 52	6,01 €	3,34 €
DIF-STR52-T	Transparente Clear	Difusor para STAR 52 Diffuser to STAR 52	4,33 €	2,40 €
DIF-STR52-30	Transparente Clear	Difusor óptica 30° para STAR 52 30° lens diffuser to STAR 52	13,23 €	7,35 €



STR-52-TPT



DIF-STR-52-30

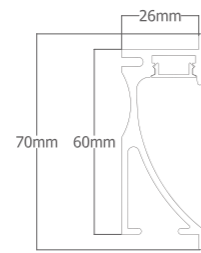

Star 54

Max. W/m
20 W

2m

AL
6060

			2m	x m
STR-54-DM		Perfil empotrable con difusor mate Recessed profile with medium frosted diffuser	116,38 €	64,66 €
STR-54-DT	Plata mate Matt silver	Perfil empotrable con difusor transparente Recessed profile with clear diffuser	116,38 €	64,66 €
STR-54-DO		Perfil empotrable con difusor opal Recessed profile with frosted diffuser	116,38 €	64,66 €
Accesorios Accessories				
STR-54-TPD	Gris Grey	Tapa final derecha Right end cup	8,18 €	
STR-54-TPI		Tapa final izquierda Left end cup	8,18 €	
DIF-STR54-M	Mate Medium frosted	Difusor para STAR 54 Diffuser to STAR 54	6,01 €	3,34 €
DIF-STR54-O	Opal Frosted	Difusor para STAR 54 Diffuser to STAR 54	6,34 €	3,52 €
DIF-STR54-T	Transparente Clear	Difusor para STAR 54 Diffuser to STAR 54	4,33 €	2,40 €



STR-54-TPI



STR-54-TPD

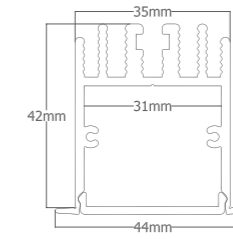

Star 55

Max. W/m
60 W

Disponible
en 6m

2m

AL
6060

			2m	x m
STR-55-DM		Perfil empotrable con difusor mate Recessed profile with medium frosted diffuser	61,34 €	34,08 €
STR-55-DT	Plata mate Matt silver	Perfil empotrable con difusor transparente Recessed profile with clear diffuser	60,54 €	33,63 €
STR-55-A		Perfil empotrable sin difusor Recessed profile without diffuser	48,17 €	26,76 €
STR-55-DM-B		Perfil empotrable con difusor mate Recessed profile with medium frosted diffuser	65,54 €	36,41 €
STR-55-DT-B	Blanco White	Perfil empotrable con difusor transparente Recessed profile with clear diffuser	64,74 €	35,96 €
STR-55-B		Perfil empotrable sin difusor Recessed profile without diffuser	52,37 €	29,09 €
STR-55-DM-N		Perfil empotrable con difusor mate Recessed profile with medium frosted diffuser	65,54 €	36,41 €
STR-55-DT-N	Negro Black	Perfil empotrable con difusor transparente Recessed profile with clear diffuser	64,74 €	35,96 €
STR-55-N		Perfil empotrable sin difusor Recessed profile without diffuser	52,37 €	29,09 €
Accesorios Accessories				
STR-55-TP	Gris Grey	Tapa final End cup	10,60 €	
STR-55-TP-B	Blanca White	Tapa final End cup	11,80 €	
STR-55-TP-N	Negra Black	Tapa final End cup	11,80 €	
STR-55-GR	Gris Grey	Grapa sujeción Fastening clip	12,00 €	
DIF-STR55-M	Mate Medium frosted	Difusor para STAR 55 Diffuser to STAR 55	13,17 €	7,32 €
DIF-STR55-T	Transparente Clear	Difusor para STAR 55 Diffuser to STAR 55	12,37 €	6,87 €



STR-55-TP



STR-55-GR

Min. 2 grapas
Min 2. fastening clips

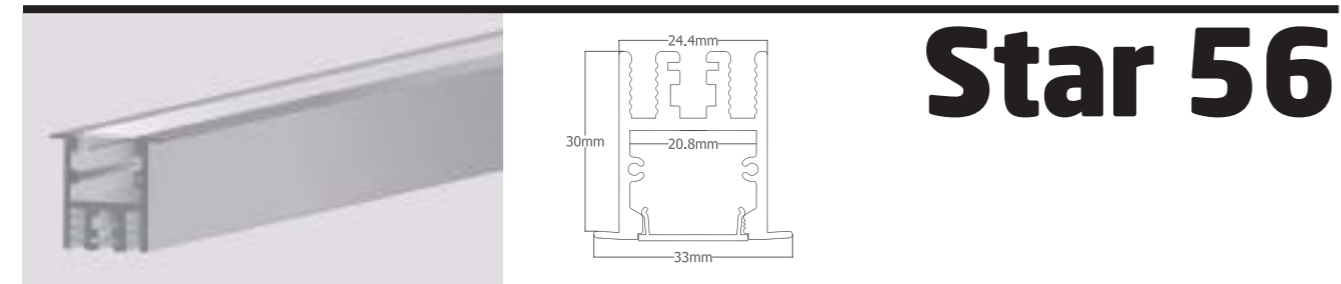

Star 56

Max. W/m
45 W

Disponible
en 6m

2m

AL
6060

			2m	x m
STR-56-DO	Plata mate Matt silver	Perfil empotrable con difusor opal Recessed profile with frosted diffuser	33,38 €	18,75 €
STR-56-DT		Perfil empotrable con difusor transparente Recessed profile with clear diffuser	32,92 €	18,29 €
STR-56-A		Perfil empotrable sin difusor Recessed profile without diffuser	27,04 €	15,02 €
STR-56-DO-B	Blanco White	Perfil empotrable con difusor opal Recessed profile with frosted diffuser	39,00 €	21,67 €
STR-56-DT-B		Perfil empotrable con difusor transparente Recessed profile with clear diffuser	38,54 €	21,41 €
STR-56-B		Perfil empotrable sin difusor Recessed profile without diffuser	32,66 €	18,14 €
STR-56-DO-N	Negro Black	Perfil empotrable con difusor opal Recessed profile with frosted diffuser	39,00 €	21,67 €
STR-56-DT-N		Perfil empotrable con difusor transparente Recessed profile with clear diffuser	38,54 €	21,41 €
STR-56-N		Perfil empotrable sin difusor Recessed profile without diffuser	32,66 €	18,14 €
Accesorios Accessories				
STR-56-TP	Gris Grey	Tapa final End cup	10,60 €	
STR-56-TP-B	Blanca White	Tapa final End cup	11,80 €	
STR-56-TP-N	Negra Black	Tapa final End cup	11,80 €	
STR-56-GR	Gris Grey	Grapa sujeción Fastening clip	1,95 €	
DIF-STR56-O	Opal Frosted	Difusor para STAR 56 Diffuser to STAR 56	6,34 €	3,52 €
DIF-STR56-T	Transparente Clear	Difusor para STAR 56 Diffuser to STAR 56	5,88 €	3,27 €



STR-56-TP



STR-56-GR
Min. 2 grapas
Min. 2 fastening clip

Restaurante Restaurante Goizeko Izarra /
Vizcaya / Tao Iluminación

Luminarias *Lights*

LED

+

Color

+

Perfil *Profile*

+

Accesorio *Accessorie*

+

Fuente de alimentación *Power supply*

Luminaria *Light*

Luminarias

"Custom your lights!" A partir del amplio catálogo de productos que ofrecemos, hacemos luminarias personalizadas. Solo en 3 pasos según:

-Lugar de instalación: techo, pared, suspendida, de pie o de sobremesa.

-Funcionalidad: dependiendo de la función que tenga que cumplir se elige la potencia desde 4.8W/m hasta 57.6W/m.

-Blanco (CCT) o color: blancos disponibles desde 2300k hasta 6000k, diferentes colores con las RGB y RGBW y efectos dinámicos con la tira de led digital.

"Custom your lights!"

From the wide catalog of products, we make customized luminaires. Only in 3 steps according to:

-Place of installation: ceiling, wall, pendant, standing or table.

-Functionality: Depending on the function you have to comply, power is selected from 4.8 W/m up to 57.6 W/m.

-White (CCT) or color: white available from 2300°K up to 6000°K, different colors with RGB and RGBW and dynamic effects with digital led strip.

Luminaria 1



Led
ARI-19,2



Perfil Profile
Star 9
Máx. 37W/m



Cable Cable
Kit-S



Led
ARI-28,8



Perfil Profile
Star 6
Máx. 37W/m



Cable Cable
Kit-S

Luminaria 2



Luminaria3



Led
MON-43,2



Perfil Profile
Star 14
Máx. 43,2W/m



Cable Cable
Kit-S



Luminaria5



Led
MON-14,2



Perfil Profile
Star2 Sides
Máx. 30W/m



Cable Cable
Kit-S



Luminaria4



Led
EN-20



Perfil Profile
Star15
Máx. 37W/m



Cable Cable
Kit-S



Luminaria6



Led
D-TTN-14



Led
EN-37-27



Perfil Profile
Star12
Máx. 60W/m

Cable Cable
Kit-S

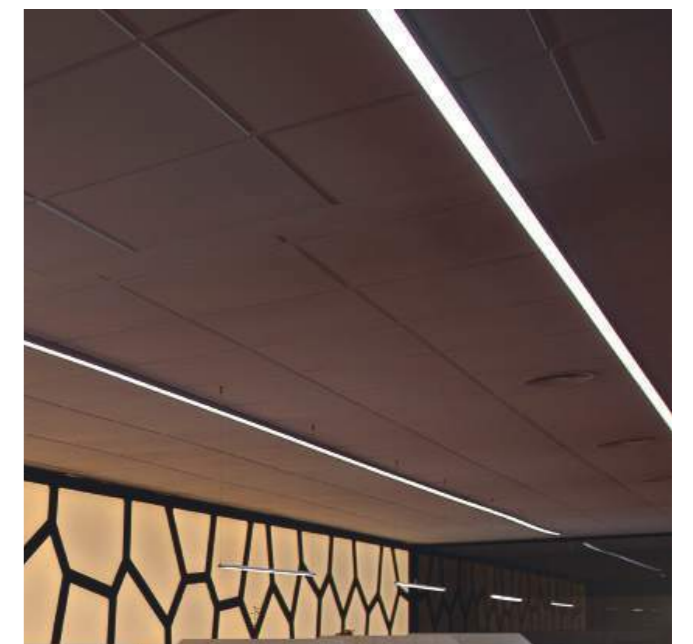

Fuentes de alimentación

Power supplies

Amplia gama de drivers y fuentes de alimentación: Clase II, Estancas, Industrial, PWM y Regulable, Batería, Kit de emergencia; todas con diferentes potencias y disponibles para 12 y 24V.

***Las alimentaciones de las fuentes son a 230V pero disponemos de 110V.**

Wide range of drivers and power supplies: Class II, Waterproof, Industrial, PWM and Dimmable, Battery, Emergency Kit; All with different powers and available for 12 and 24V.

*The voltages of power supplies are 230V but we have 110V.

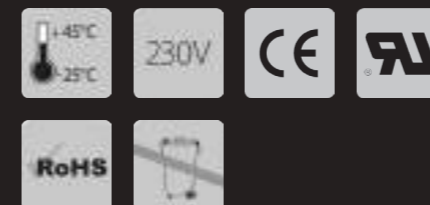

Clase II <i>Class II</i>	120
Estanca <i>Waterproof</i>	121
Industrial <i>Industrial</i>	121
PWM Regulable <i>Dimmable PWM</i>	122
Batería <i>Battery</i>	122
Kit emergencia <i>Emergency Kit</i>	123

Fuentes de alimentación

Power supplies

Fuente de alimentación clase II. De tensión constante.

Class II power supply. Constant voltage.



FAC

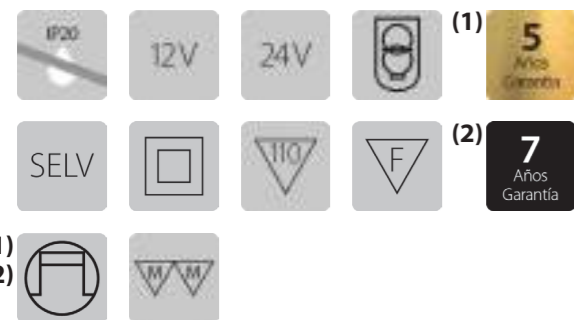

FAC-15	15W	125 x 45 x 20 mm	14,00 €
FAC-20	20W	150 x 46 x 23 mm	16,56 €
FAC-30	30W	160 x 60 x 20 mm	28,80 €
FAC-35	35W	160 x 40 x 30 mm	29,80 €
FAC-60	60W	175 x 43 x 32 mm	32,00 €
FAC-100	100W	205 x 52 x 37 mm	53,64 €
FAC-150	150W	225 x 64 x 38 mm	76,80 €
FAC-240 (1)	240W	244 x 64 x 38 mm	129,60 €
FAC-320 (2)	320W	252 x 90 x 40 mm	214,62 €

Los precios son para las de 24V. Otros voltajes y potencias a consultar. The prices are for 24V. Other voltages and power to consult.



LCU

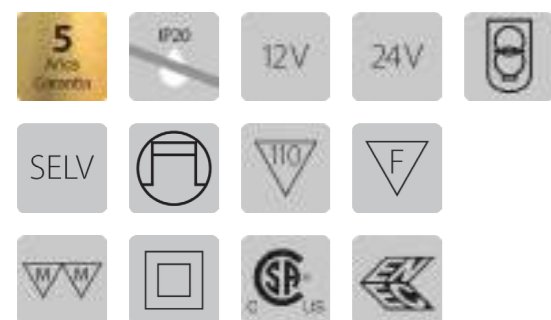

LCU-35	35W	220 x 40 x 20 mm	45,10 €
LCU-60	60W	250 x 40 x 20 mm	67,78 €
LCU-96	96W	300 x 40 x 20 mm	81,50 €
LCU-180	180W	260 x 65 x 30 mm	134,00 €

Los precios son para las de 24V. Otros voltajes y potencias a consultar. The prices are for 24V. Other voltages and power to consult.

Fuentes de alimentación

Power supplies

Fuente de alimentación estanca. De tensión constante. Para instalaciones de interior o exterior. Evite la exposición directa al sol.

Waterproof power supply. Constant voltage. For indoor or outdoor installations. Avoid direct sun exposure.



FAE



FAE-35	35W	160 x 40 x 30 mm	29,80 €
FAE-60	60W	175 x 43 x 32 mm	32,00 €
FAE-100	100W	205 x 52 x 37 mm	53,64 €
FAE-150	150W	225 x 64 x 38 mm	76,80 €
FAE-240 (1)	240W	244 x 64 x 38 mm	129,60 €
FAE-320 (2)	320W	252 x 90 x 40 mm	214,62 €

Los precios son para las de 24V. Otros voltajes y potencias a consultar. The prices are for 24V. Other voltages and power to consult.

Fuente de alimentación industrial. De tensión constante.

Industrial power supply. Constant voltage.



FAI



FAI-35	35W	100 x 82 x 30 mm	22,66 €
FAI-50	50W	100 x 82 x 30 mm	22,32 €
FAI-75	75W	100 x 99 x 30 mm	27,36 €
FAI-100	100W	130 x 97 x 30 mm	30,60 €
FAI-150	150W	160 x 97 x 30 mm	37,44 €
FAI-200	200W	215 x 115 x 30 mm	80,15 €
FAI-320*	320W	215 x 115 x 30 mm	98,00 €

Solo para uso industrial For industrial use only
* Con ventilador Fan incl.

Los precios son para las de 24V. Otros voltajes y potencias a consultar. The prices are for 24V. Other voltages and power to consult.

Fuentes de alimentación

Power supplies

Fuente de alimentación PWM regulable. De tensión constante. Salida PWM con una frecuencia de 300 Hz. Para instalaciones de interior o exterior. Evite la exposición directa al sol.

Adjustable power supply. Constant voltage. PWM output with a frequency of 300 Hz. For indoor or outdoor installations. Avoid direct sun exposure.



PWM

PWM regulable
PWM dimmable



FAP-60	60W	150 x 53 x 35 mm	70,56 €
FAP-120	120W	191 x 63 x 38 mm	113,04 €

Los precios son para las de 24V. Otros voltajes y potencias a consultar. The prices are for 24V. Other voltages and power to consult.

Batería. De tensión constante recargable. Más de 2000 ciclos de carga. Para instalaciones de interior o exterior (protección contra agua de lluvia).

Battery. Constant voltage rechargeable. More than 2000 charge cycles. For indoor or outdoor installations (protection against rainwater).

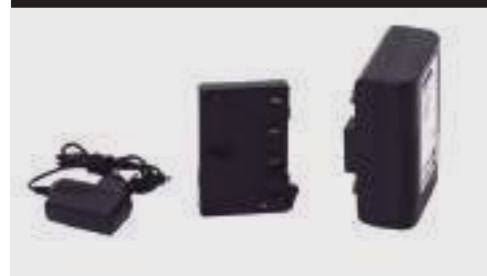

BAT

Batería
Baterly



BAT-180-24	180W	145 x 95 x 78 mm	412,50 €
BAT-260-24	260W	145 x 95 x 78 mm	495,00 €
BAT-360-24	360W	145 x 95 x 78 mm	643,50 €

Los precios son para las de 24V. Otros voltajes y potencias a consultar. Disponible a 12V. The prices are for 24V. Other voltages and power to consult. 12V to available.

Fuentes de alimentación

Power supplies

KIT Emergencia. Unidad electrónica de emergencia que funciona con tensión constante. Incluye batería de alta eficiencia.

Emergency kit. Electronic emergency unit that operate with constant voltage. Includes high efficiency battery.



Kit Emergencia

Emergencia
Emergency

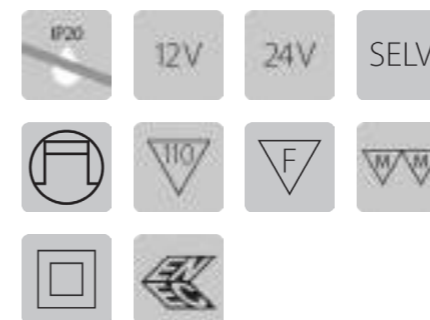

KFE-24	Equipo Electronic unit 156 x 51,5 x 25,5 mm Bateria Battery 135 x 45 x 23 mm	89,20 €
---------------	---	---------

12V DC 1 x 24W
24V DC 1 x 48W

Los precios son para las de 24V. Otros voltajes y potencias a consultar. The prices are for 24V. Other voltages and power to consult.

Museu de les Cultures del Mon
Barcelona
Hazluz 17

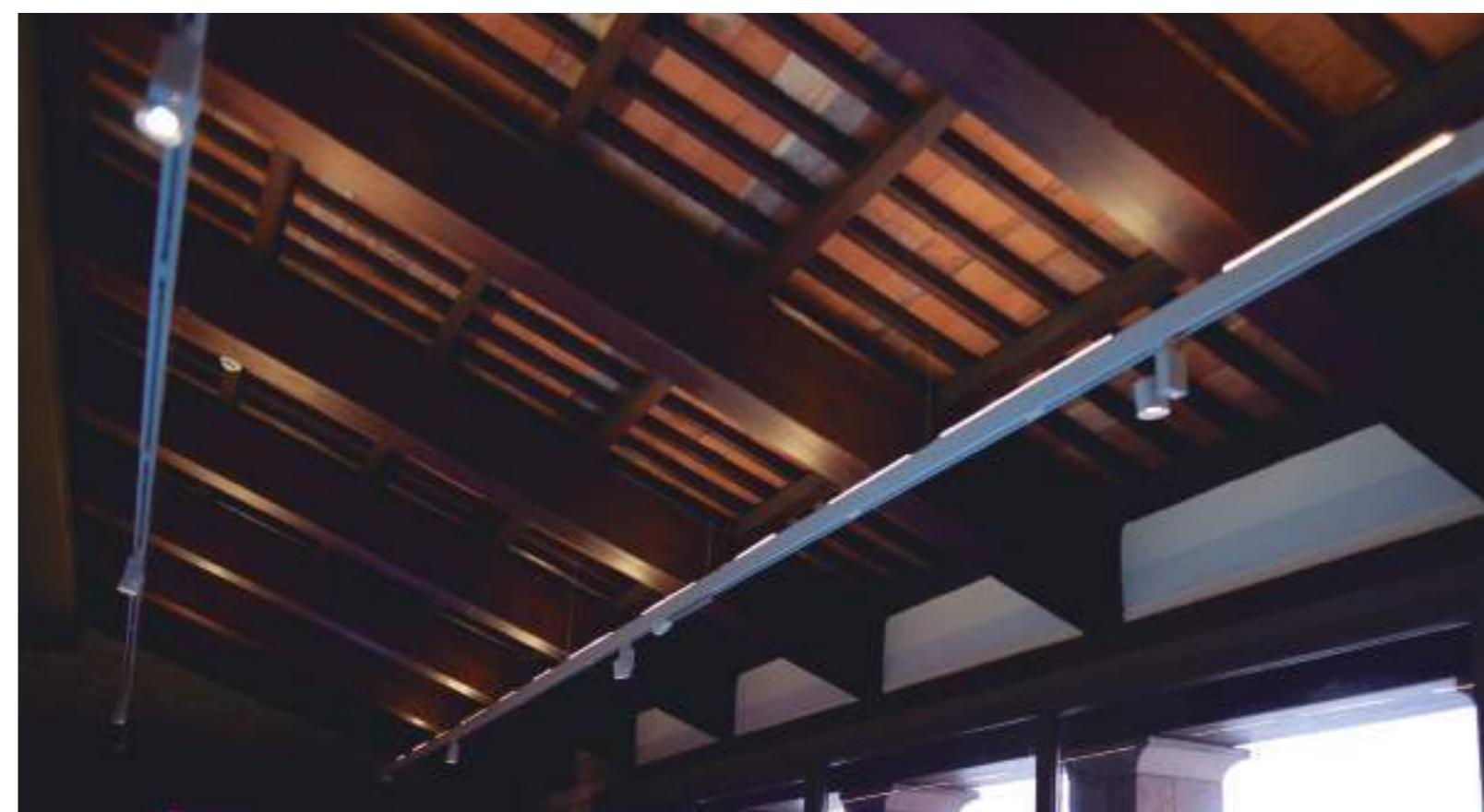

Sistemas de control

Control systems

Dimmer 1 y 2 canales <i>Dimmer 1 and 2 channels</i>	126
Programador 3 y 4 canales <i>Controller 3 and 4 channels</i>	132
Convertidor <i>Converter</i>	136
Repetidores, receptores y accesorios <i>Repeaters, receivers and accessories</i>	140

Dimmer 1y 2 canales Dimmer 1 and 2 channels

Amplia gama de dimmers que permiten regular la intensidad de nuestras tiras de 1 canal y 2 canales. Disponible con diferentes modos de control: mando a distancia, pulsador y a través de aplicación Android o iOS.

Wide range of dimmers that allow to regulate the intensity of our strips of 1 channel and 2 channels. Available with different control modes: remote control, push button and through Android or iOS application.



DMPx

Dimmer 1 canal
Dimmer 1 channel



12V DC 1 x 144W
24V DC 1 x 288W

DMPx Caja para empotrar Recessed box 82 x 82 x 48 mm 52,45 €
Pantalla táctil Touch panel 86 x 86 x 36 mm

Dimmer táctil. Selector de intensidad. Función AUTO OFF en 30 segundos. Permite memorizar un nivel fijo. Conserva memoria de estado y posición. Incluye caja para empotrar.

Touch dimmer. Selector of intensity. AUTO OFF function in 30 seconds. It allows to memorize a fixed level. Preserves state and position memory. Includes box to recessed.

Accesorios Accessories	Pág. 141
RP-DMR-150	Repetidor / Repeater
RP-DMR-360	Repetidor / Repeater



DMR-Tx

Dimmer 1 canal
Dimmer 1 channel



12V DC 1 x 108W
24V DC 1 x 216W

DMR-Tx Receptor Receiver 135 x 30 x 20 mm 52,45 €
Mando Remote control 104 x 60 x 9 mm

Dimmer vía radio. Selector de intensidad. Función AUTO OFF en 30 segundos. Permite memorizar un nivel fijo. Conserva memoria de estado y posición. Permite enlazar más de un receptor por mando a distancia. Incluye soporte para mando a distancia.

Wireless dimmer. Selector of intensity. AUTO OFF function in 30 seconds. It allows to memorize a fixed level. Preserves state and position memory. It allows to link more than one receiver by remote control. Includes support for remote control.

Accesorios Accessories	Pág. 141
REC-3A-X	Receptor / Receiver
RP-DMR-150	Repetidor / Repeater
RP-DMR-360	Repetidor / Repeater



DMR-75

Dimmer 1 canal
Dimmer 1 channel



12V DC 1 x 75W
24V DC 1 x 150W

DMR-75 125 x 50 x 25 mm 65,92 €

Dimmer. Funciona con pulsador libre de carga (no incluido). Conserva memoria de estado y posición.
Dimmer. It works with push-button without charge (not included). Preserves state and position memory.

Accesorios Accessories	Pág. 141
RP-DMR-150	Repetidor / Repeater
RP-DMR-360	Repetidor / Repeater

DMR-150

Dimmer 1 canal
Dimmer 1 channel



12V DC 1 x 150W
24V DC 1 x 300W

DMR-150 117 x 80 x 45 mm 94,76 €

Dimmer. Funciona con pulsador libre de carga (no incluido). Conserva memoria de estado y posición.
Dimmer. It works with push-button without charge (not included). Preserves state and position memory.

Accesorios Accessories	Pág. 141
RP-DMR-150	Repetidor / Repeater
RP-DMR-360	Repetidor / Repeater

INT-TL-D

Dimmer 1 canal
Dimmer 1 channel



12V DC 1 x 55W
24V DC 1 x 110W

INT-TL-D 50 x 11 mm
Altura mín. 5 mm máx. 11 mm
Height min. 5mm max. 11m 21,63 €

Dimmer táctil. Apto para instalar en perfil de aluminio. Conserva memoria de estado y posición.
Touch dimmer. Suitable for installation in aluminum profile. Preserves state and position memory.
Compatible with: STR-4, STR-6, STR-7, STR-9, STR-17, 2 Sides, STR-52.

Accesorios Accessories	Pág. 141
RP-DMR-150	Repetidor / Repeater
RP-DMR-360	Repetidor / Repeater

DMR-Mini

Dimmer 1 canal
Dimmer 1 channel



Pequeñas dimensiones.
Small dimensions.



12V DC 1 x 96W
24V DC 1 x 192W

DMR-MINI 46 x 12 x 5 mm 21,30 €

Dimmer. Funciona con pulsador libre de carga (no incluido). Conserva memoria de estado y posición.
Dimmer. It works with push-button without charge (not included). Preserves state and position memory.

Accesorios Accessories	Pág. 141
RP-DMR-150	Repetidor / Repeater
RP-DMR-360	Repetidor / Repeater



DMR-Smart

Dimmer 1 canal
Dimmer 1 channel

Pequeñas dimensiones.
Small dimensions.

Bluetooth



12V DC 1 x 180W
24V DC 1 x 360W

DMR-SMART	87 x 21 x 8.5 mm	81,06 €
------------------	------------------	---------

Dimmer. Funciona con Bluetooth, compatible con Android e iOS. Conserva memoria de estado y posición. Permite memorizar hasta 16 niveles diferentes.
Dimmer. Works with Bluetooth, compatible with Android and iOS. Preserves state and position memory. It allows to store up to 16 different levels.

Accesorios Accessories	Pág. 141 y 143
RP-DMR-150	Repetidor / Repeater
RP-DMR-360	Repetidor / Repeater
RC-SMART	Mando / Remote control



DMR-T2x

Dimmer 2 canales
Dimmer 2 channels



12V DC 2 x 36W
24V DC 2 x 72W

DMR-T2x	Receptor Receiver 135 x 30 x 20 mm Mando Remote control 104 x 60 x 9 mm	60,67 €
----------------	--	---------

Dimmer vía radio. Regula nivel de intensidad de 2 canales. Selector de intensidad. Incluye una escena que va oscilando entre los dos canales. Conserva memoria de estado y posición. Incluye soporte para mando a distancia.
Wireless dimmer to control constant voltage LEDs. Adjusts the intensity level of 2 channels. Selector of intensity. It includes a scene that oscillates between the two channels. Preserves state and position memory. Includes support for remote control.

Accesorios Accessories	Pág. 141 y 142
REC-3A-X	Receptor / Receiver
RP-RGB-150	Repetidor / Repeater



Programador 3 y 4 canales Controller 3 and 4 channels

Amplia gama de programadores que permiten regular la intensidad y generar escenas de cambios de color, con diferentes velocidades, de nuestras tiras de led RGB y RGBW. Disponible con diversos modos de control: mando a distancia, pulsador y a través de aplicación Android o iOS.

Wide range of programmers that allow you to regulate the intensity and generate scenes of color changes, with different speeds, of our RGB and RGBW led strips. Available with various control modes: remote control, push button and through Android or iOS application.



PCM-Tx

Programador 3 canales
Controller 3 channels



12V DC 3 x 36W
24V DC 3 x 72W



PCM-Tx	Receptor Receiver 135 x 30 x 20 mm Mando Remote control 104 x 60 x 9 mm	65,60 €
---------------	--	---------

Programador vía radio para controlar leds RGB. Selección de 11 escenas que incluyen cambios de color y colores fijos. Selector de color. Conserva memoria de estado y posición. Permite enlazar más de un receptor por mando a distancia. Incluye soporte para mando a distancia.
Wireless controller for RGB LEDs. Selection of 11 scenes including color changes and fixed colors. Color picker. Preserves state and position memory. It allows to link more than one receiver by remote control. Includes support for remote control.

Accesorios Accessories	Pág. 141 y 142
REC-3A-X	Receptor / Receiver
RP-RGB-150	Repetidor / Repeater
RP-RGB-360	Repetidor / Repeater

PCM-T-10x

Programador 3 canales
Controller 3 channels



12V DC 3 x 60W
24V DC 3 x 120W
**Para 10 zonas.
For 10 zones.**



PCM-T-10x	Receptor Receiver 215 x 42 x 32 mm Mando Remot control 145 x 55 x 22 mm	146,43 €
------------------	--	----------

Programador vía radio para controlar leds RGB. Selección de 18 escenas que incluyen cambios de color y colores fijos. Selector de color con indicador luminoso. Conserva memoria de estado y posición. Permite enlazar más de un receptor por mando a distancia. Incluye soporte para mando a distancia y cable para cargar el mando a distancia.
Wireless controller for RGB LEDs. Selection of 18 scenes including color changes and fixed colors. Color selector with indicator light. Preserves state and position memory. It allows to link more than one receiver by remote control. Includes support for remote control and cable to charge the remote control.

Accesorios Accessories	Pág. 142
P-10-X	Receptor / Receiver
RP-RGB-150	Repetidor / Repeater
RP-RGB-360	Repetidor / Repeater

Sistemas de control Control systems



PCP

Programador 3 canales
Controller 3 channels



12V DC 3 x 50W
24V DC 3 x 100W

PCP 125 x 50 x 25 mm 73,50 €

Programador para controlar leds RGB. Funciona con 3 pulsadores libres de carga (no incluidos). Selección de 7 colores fijos y cambio de color automático con 3 velocidades. Conserva memoria de estado y posición. Posibilidad de personalizar las escenas y secuencias.
Controller for RGB LEDs. It works with 3 push-button without charge (not included). Selection of 7 fixed colors and 3 speed automatic color change. Preserves state and position memory. Possibility to customize the scenes and sequences and position memory. Possibility to customize the scenes and sequences.

Accesorios Accessories	Pág. 142
RP-RGB-150	Repetidor / Repeater
RP-RGB-360	Repetidor / Repeater



PCM-Smart

Programador 3 canales
Controller 3 channels

Pequeñas dimensiones.
Small dimensions.

Bluetooth



12V DC 3 x 60W
24V DC 3 x 120W

PCM-SMART 87 x 21 x 8,5 mm 84,20 €

Programador para controlar leds RGB. Funciona con Bluetooth, compatible con Android e iOS. Conserva memoria de estado y posición. Permite seleccionar colores fijos y 42 escenas que de cambios de color.
Controller for RGB LEDs. Works with Bluetooth, compatible with Android and iOS. Preserves state and position memory. It allows to select fixed colors and 42 scenes that of color changes.

Accesorios Accessories	Pág. 141 y 143
RP-RGB-150	Repetidor / Repeater
RP-RGB-360	Repetidor / Repeater
RC-SMART	Mando / Remote control

Sistemas de control Control systems



PPT-4

Programador 4 canales
Controller 4 channels



12V DC 4 x 48W
24V DC 4 x 96W

PPT-4 Caja para empotrar Recessed box 82 x 82 x 48 mm 66,63 €
Pantalla táctil Touch panel 86 x 86 x 36 mm

Programador táctil para controlar leds RGB y RGBW. Selección de 11 escenas que incluyen cambios de color y colores fijos. Selector de color. En los leds RGBW permite controlar de manera independiente el canal del color blanco. Conserva memoria de estado y posición.
Touch controller for RGB and RGBW LEDs. Selection of 11 scenes including color changes and fixed colors. Color picker. In the RGBW LEDs, you can independently control the white color channel. Preserves state and position memory.

Accesorios Accessories	Pág. 143
RP-RGBW-150	Repetidor / Repeater



PCM-T4

Programador 4 canales
Controller 4 channels



12V DC 4 x 60W
24V DC 4 x 120W

PCM-T4 Receptor Receiver 175 x 44 x 30 mm 126,80 €
Mando Remote control 104 x 60 x 9 mm

Programador vía radio para controlar leds RGB y RGBW. Selección de 12 escenas que incluyen cambios de color y colores fijos. Selector de color. En los leds RGBW permite controlar de manera independiente el canal del color blanco. Conserva memoria de estado y posición.
Wireless controller for RGB and RGBW leds. Selection of 12 scenes including color changes and fixed colors. Color picker. In the RGBW LEDs, you can independently control the white color channel. Preserves state and position memory.

Accesorios Accessories	Pág. 143
REC-4A-X	Receptor / Receiver
RP-RGBW-150	Repetidor / Repeater

Convertidor Converter

Convertidores (pasarelas) para enlazar nuestras tiras led a diferentes plataformas de control: DMX, 1-10V, 0-10V, DALI y KNX.

Converters (gateways) to link our led strips to different control platforms: DMX, 1-10V, 0-10V, DALI and KNX.

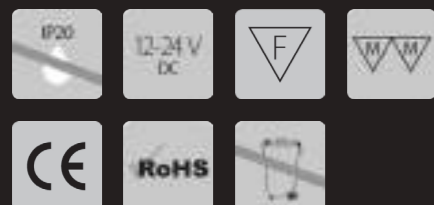

DMR-0-10-75

Convertidor 1 canal
Converter 1 channel



12V DC 1 x 75W
24V DC 1 x 150W

DMR-0-10-75 125 x 50 x 25 mm 83,79 €

Convertidor de señal 0-10V.
0-10V converter.

DMR-DA

Convertidor 1 canal
Converter 1 channel



12V DC 1 x 144W
24V DC 1 x 288W

DMR-DA 156 x 51,5 x 25,5 mm 83,58 €

Convertidor compatibles con las señales DALI, 0-10V, 1-10V y PUSH.
Converter compatible with DALI, 0-10V, 1-10V and PUSH signals.

DMR-KNX-3

Convertidor 3 canales
Converter 3 channels



12V DC 3 x 30W
24V DC 3 x 60W

DMR-KNX-3 157 x 44 x 22 mm 347,36 €

Convertidor de señal KNX. Permite controlar una zona RGB o 3 zonas monocolor.
Dispone de función autotest para comprobar el funcionamiento de los canales.
KNX signal converter. Allows you to control an RGB zone or 3 monochrome zones.
It has a self-test function to check the operation of the channels.



DMR-KNX-4

Convertidor 4 canales
Converter 4 channels



12V DC 4 x 30W
24V DC 4 x 60W

DMR-KNX-4 157 x 44 x 22 mm 422,33 €

Convertidor de señal KNX. Permite controlar una zona RGBW o 4 zonas monocolor. Dispone de función autotest para comprobar el funcionamiento de los canales. KNX signal converter. Allows you to control an RGBW zone or 4 monochrome zones. It has a self-test function to check the operation of the channels.



DMR-KNX-DIN4

Convertidor 4 canales
Converter 4 channels



12V DC 4 x 72W
24V DC 4 x 144W

Para carril DIN.
For DIN track.

DMR-KNX-DIN4 Compatible con carril DIN
Compatible with DIN track 522,29 €

Convertidor de señal KNX. Permite controlar una zona RGBW o 4 zonas monocolor. Dispone de función autotest para comprobar el funcionamiento de los canales. KNX signal converter for constant voltage LEDs. Allows you to control an RGBW zone or 4 monochrome zones. It has a self-test function to check the operation of the channels.

Clínica Dental San Vicente
Vizcaya
Tao Iluminación
Erlantz Biderbost



Repetidores, receptores y accesorios Repeaters, receivers and accessories

**Accesorios que permiten amplificar o repetir la señal.
Ideal para instalaciones de mediano o gran tamaño.**

Accessories that allow you to amplify or repeat the signal. Ideal for medium or large installations.



REC-3A-X

Receptor 3 canales
Receiver 3 channels

Polivalente para 1, 2 y 3 canales
Multi-purpose for 1, 2, and 3 channels



12V DC 3 x 36W
24V DC 3 x 72W

REC-3A-X 135 x 30 x 20 mm 32,88 €

Receptor vía radio compatible con los mandos a distancia de los modelos DMT-Tx, DMR-T2x y PCM-Tx. Se pueden enlazar más de un receptor por mando a distancia. Necesita mando a distancia para funcionar.
Wireless receiver compatible with remote controls of the DMT-Tx, DMR-T2x and PCM-Tx models. More than one receiver can be connected by remote control. Need remote control to work.



RP-DMR-150

Repetidor 1 canal
Repeater 1 channel



12V DC 1 x 150W
24V DC 1 x 300W

RP-DMR-150 125 x 50 x 25 mm 63,86 €

Repetidor compatible con todos los dimmers de 1 canal.
Repeater compatible with all 1 channel dimmers.



RP-DMR-360

Repetidor 1 canal
Repeater 1 channel

Pequeñas dimensiones.
Small dimensions.



12V DC 1 x 180W
24V DC 1 x 360W

RP-DMR-360 87 x 21 x 8.5 mm 44,50 €

Repetidor compatible con todos los dimmers de 1 canal.
Repeater compatible with all 1 channel dimmers.



P-10-X

Receptor 3 canales
Receiver 3 channels



12V DC 3 x 60W
24V DC 3 x 120W

P-10-X 215 x 42 x 32 mm 126,48 €

Receptor vía radio compatible con el mando a distancia del modelo PCM-T-10x. Se pueden enlazar más de un receptor por mando a distancia. Necesita mando a distancia para funcionar.
Wireless receiver compatible with remote control of model PCM-T-10x. More than one receiver can be connected by remote control. Need remote control to work.



RP-RGB-150

Repetidor 3 canales
Repeater 3 channels



12V DC 3 x 50W
24V DC 3 x 100W

RP-RGB-150 125 x 50 x 25 mm 67,20 €

Repetidor compatible con todos los Programadores y Convertidores RGB.
Repeater compatible with all controllers and RGB Converters.



RP-RGB-360

Repetidor 3 canales
Repeater 3 channels

Pequeñas dimensiones.
Small dimensions.



12V DC 3 x 60W
24V DC 3 x 120W

RP-RGB-360 87 x 21 x 8.5 mm 46,50 €

Repetidor compatible con todos los Programadores y Convertidores RGB.
Repeater compatible with all controllers and RGB Converters.



REC-4A-X

Receptor 4 canales
Receiver 4 channels

Polivalente para 1, 2, 3 y 4 canales
Multi-purpose for 1, 2, 3 and 4 channels



12V DC 4 x 60W
24V DC 4 x 120W

REC-4A-X 175 x 44 x 30 mm 69,30 €

Receptor vía radio compatible con los mandos a distancia de los modelos DMR-Tx, DMR-T2x, PCM-Tx y PCM-T4. Se pueden enlazar más de un receptor por mando a distancia. Necesita mando a distancia para funcionar.
Wireless compatible with DMT-Tx, DMR-T2x, PCM-Tx and PCM-T4 remote controls. More than one receiver can be connected by remote control. You need remote control to operate.



RP-RGBW-150

Repetidor 4 canales
Repeater 4 channels



12V DC 4 x 37W
24V DC 4 x 75W

RP-RGBW-150 125 x 50 x 25 mm 67,20 €

Repetidor compatible con todos los Programadores y Convertidores RGBW.
Repeater compatible with all controllers and RGBW Converters.



RC-Smart

Mando a distancia
Remot control

RC-SMART 122 x 35 x 10 mm 14,50 €

Mando a distancia compatible con los modelos DMR-SMART y PCM-SMART.
Remote control compatible with DMR-SMART y PCM-SMART models.

LLURIA

Iluminación dinámica *Dynamic lighting*

Iluminación dinámica *Dynamic lighting*

Introducción <i>Introduction</i>	148
Productos <i>Products</i>	
1. Sistemas de control <i>Control systems</i>	150
Diferido <i>Stand alone</i>	
Directo <i>Live</i>	
2. Tira LED digital <i>Digital LED strip</i>	158
3. Cableado y links <i>Wiring and links</i>	164
4. Kits	166
5. Luminaria Tesella <i>Tesella lamp</i>	170
6. DMX	174
Programadores <i>Control</i>	
Convertidores <i>Converters</i>	

Introducción



La **Iluminación Dinámica** significa dar un paso más en la creación de espacios vivos, la faceta más emocional de la iluminación es hoy más natural gracias a un ecosistema de productos que pone en la mano del diseñador la posibilidad de expresar emociones con la luz. Después de un extenso trabajo de desarrollo, presentamos una **gama de productos** que permite infinitas posibilidades, acompañado de una **propuesta propia de contenido** y una filosofía de **instalación** para hacer mucho más **sencillo** el trabajo de los profesionales que materializan los proyectos, tanto a nivel creativo como técnico. Con nuestro **sistema de control Lightbox**, acercamos una tecnología superior en iluminación decorativa a clientes que hasta ahora no tenían acceso a ella y facilitamos el trabajo a aquellos profesionales que ya hacían instalaciones de iluminación dinámica. Una instalación hecha con **Lightbox** propone varios conceptos de iluminación para que el cliente no elija un color o una intensidad, sino que elija entre expresiones de iluminación.

Introduction



Dynamic Lighting means taking one step further in creating living spaces, the most emotional facet of lighting is today more natural thanks to a product ecosystem that puts the designer's hand in the possibility of expressing emotions with light. After an extensive development work, we present a **range of products** that allows infinite possibilities, accompanied by a **proprietary content proposal** and an **installation** philosophy to make the work of the professionals who materialize the projects much **easier**, both creatively and technical. With our **Lightbox control system**, we bring a superior technology in decorative lighting to customers that have not had access to it until now, and we make it easier for those professionals who were already doing dynamic lighting installations. An installation made with **Lightbox** proposes several lighting concepts so that the client does not choose a color or intensity, but choose between expressions of light.



Lluria Iluminacion

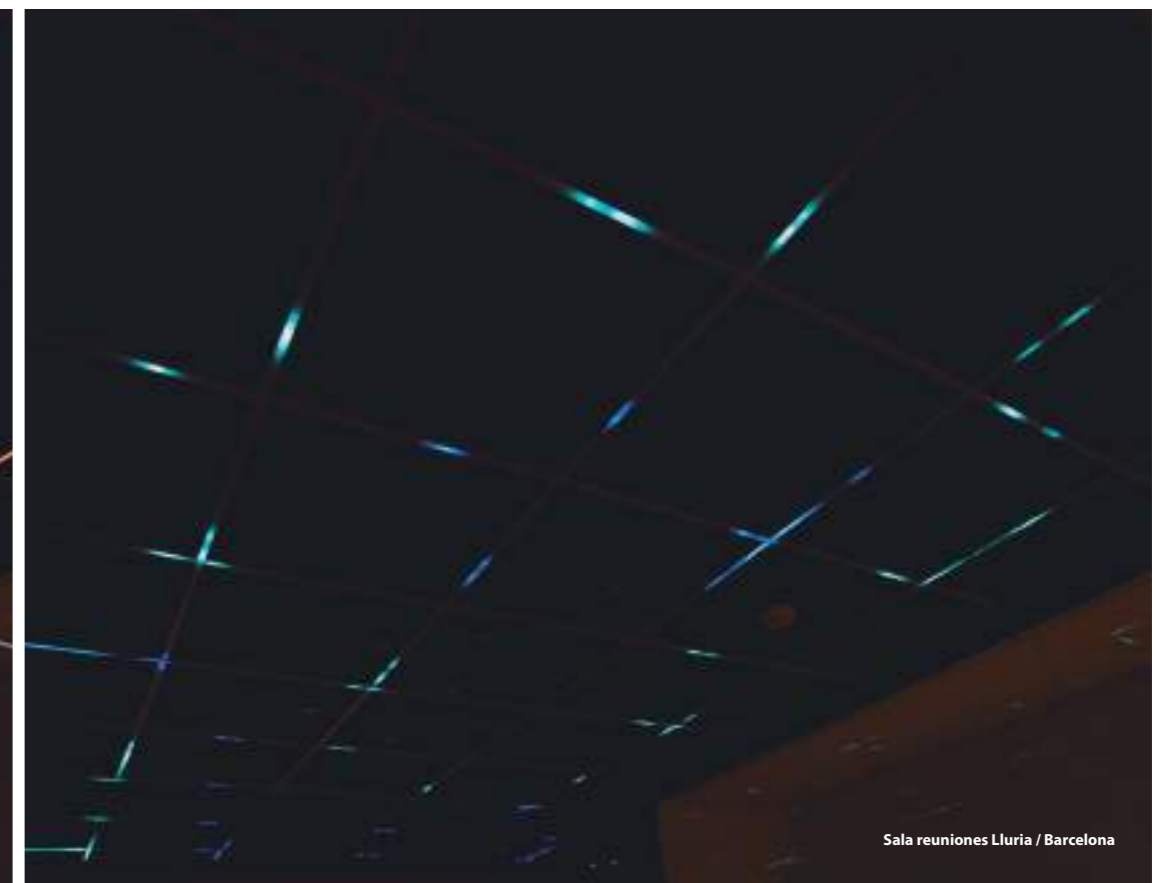
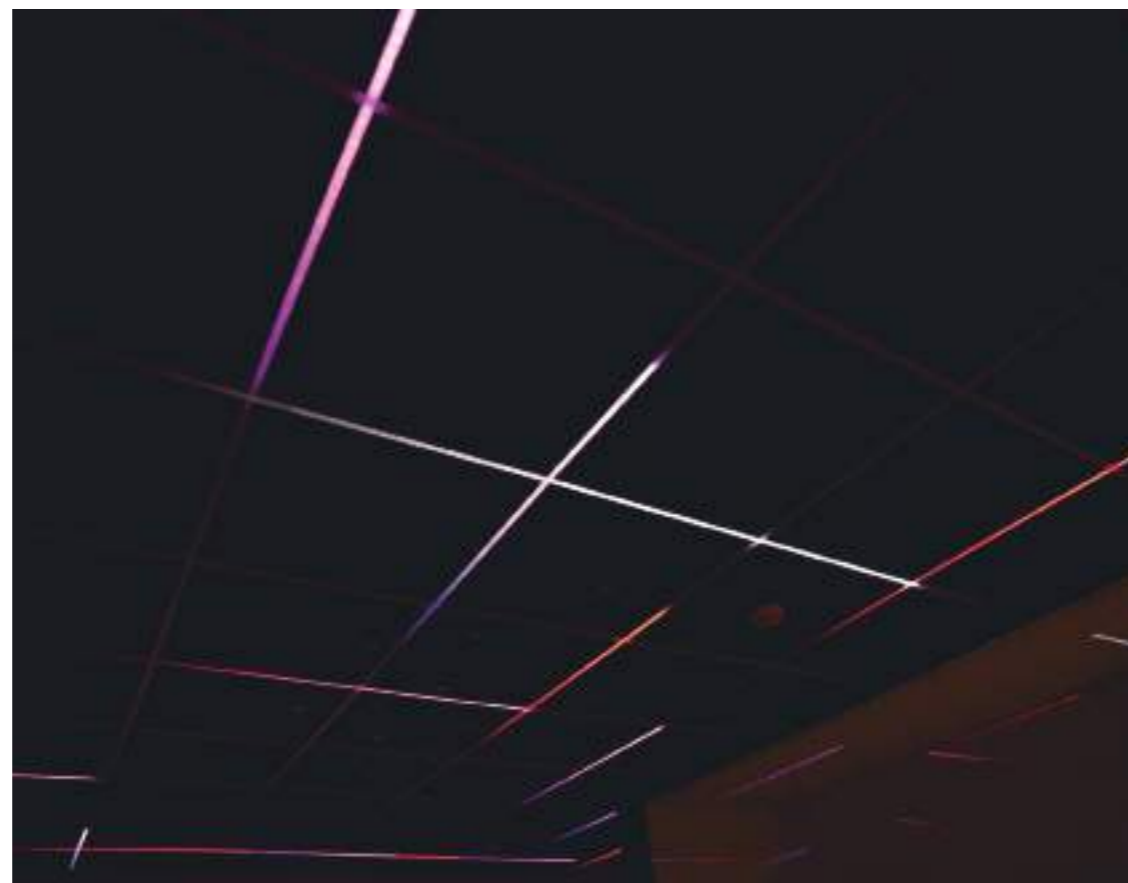

Sala reuniones Lluria / Barcelona

Sistemas de control digital Digital control system

-La familia Lightbox permite controlar en directo o en diferido diferentes tamaños de instalaciones.

-The Lightbox family allows live or delayed control of different sizes of installations.



-Diferido Stand alone
-Directo Live

Lightbox



El sistema **Lightbox** incluye una propuesta de contenido propio que soluciona las mayores dificultades para diseñar una instalación de iluminación dinámica antes de empezar a trabajar. Independientemente de cómo se diseñe y el número de elementos que la compongan, podremos elegir entre **Programaciones estándar** desarrolladas por Lluria o **Programaciones totalmente a medida** de las necesidades del cliente. Las **programaciones estándar** diseñadas, se basan en estudios realizados sobre la percepción de los colores en los seres humanos. Son **8 conceptos evocadores** que convertirán el espacio en un lugar vivo, y que nos permitirán elegir cómo queremos que la iluminación nos transmita diferentes sensaciones naturales de bienestar:

Programas estándar incluidos: Elegante, Relajante, Vital, Impacto, Aire, Agua, Tierra y Fuego.

Programación a medida: desde nuestro Departamento de Proyectos podemos realizar cualquier programa/s a medida. Simplemente hay que volver a grabar la tarjeta SD o enviar el archivo on-line.

Programas estándar RGB:
Standard programs RGB:

RGB

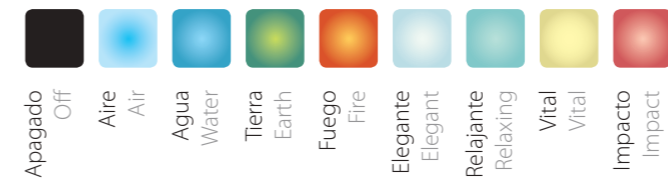

Lightbox



The **Lightbox** system includes a proprietary content proposal that solves the greatest difficulties in designing a dynamic lighting installation before starting to work. Regardless of how it is designed and the number of elements that compose it, we can choose between **Standard programs** developed by Lluria or **schedules totally Customized** to the client's needs. The **standard programs** designed are based on studies on the perception of colors in humans. There are **8 evocative concepts** that will turn space into a living place, and that will allow us to choose how we want lighting to transmit us different natural sensations of well-being:

Standard programs included: Elegant, Relaxing, Vital, Impact, Air, Water, Earth and Fire.

Custom programming: from our Project Department, we can carry out any customized program (s). Simply re-record the SD card or send the file online.

Programas estándar Blancos:
Standard White programs:

Blanco White

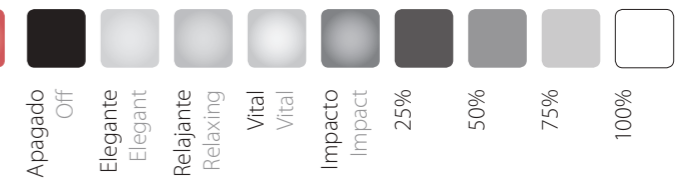

Ejemplo de instalación Sistema Lightbox Installation example Lightbox System

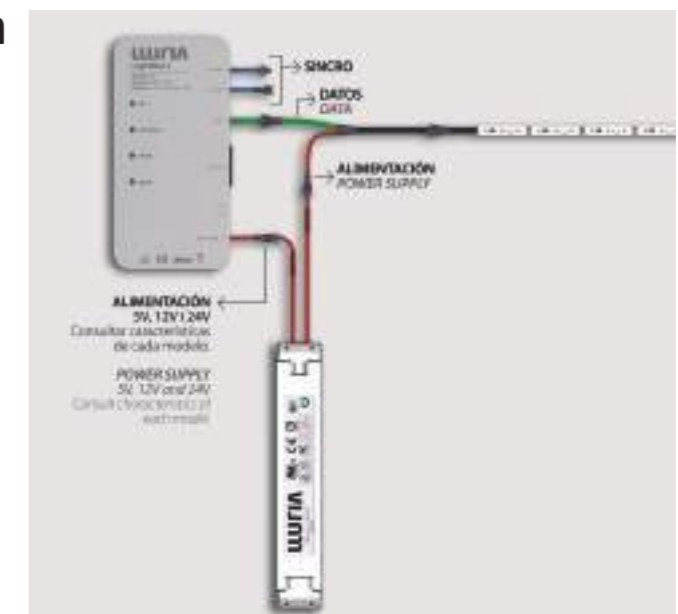

- Diferido
- Stand alone



Lightbox Basic

Diferido
Stand alone

LB1-B 150 x 72 x 24 mm 135,00 €

Programador para instalaciones basadas en pixels. Dispone de un puerto de salida de datos. Puede controlar hasta 200px (10m). Necesita tarjeta SD para su funcionamiento. Permite modificar número de escena y velocidad de reproducción. Incluye adaptador 5V – AC/DC.
Controller for installations based on pixels. It has a data output port. It can control up to 200px (10m). Requires SD card for operation. It allows to modify scene number and playback speed. 5V – AC/DC adapter included.



Lightbox 1

Diferido
Stand alone

LB1 132 x 70 x 20 mm 280,00 €

Programador para instalaciones basadas en pixels. Dispone de un puerto de salida de datos. Puede controlar hasta 400px (20m). Necesita tarjeta SD para su funcionamiento. Permite modificar número de escena y velocidad de reproducción. Se puede sincronizar con otros LB1 y LB8 para instalaciones de más de 400px.
Controller for installations based on pixels. It has a data output port. It can control up to 400px (20m). Requires SD card for operation. It allows to modify scene number and playback speed. It can be synchronized with other LB1 and LB8 for installations of more than 400px.



Lightbox 8

Diferido
Stand alone

LB8 132 x 156 x 20 mm 850,00 €

Programador para instalaciones basadas en pixels. Dispone de ocho puertos de salida de datos. Puede controlar hasta 400px (20m) por puerto (total 3200px). Necesita tarjeta SD para su funcionamiento. Se puede sincronizar con otros LB1 y LB8 para instalaciones de más de 3200px. Para modificar el número de escena y velocidad de reproducción es necesario el accesorio DMR-LB8 o DMX-DIG.
Controller for installations based on pixels. It has eight data output ports. It can control up to 400px (20m) per port (total 3200px). Requires SD card for operation. It can be synchronized with other LB1 and LB8 for installations of more than 3200px. To modify the scene number and playback speed, the DMR-LB8 or DMX-DIG accessory is required.



LB-AM-D

Diferido
Stand alone

LB-AM-D 55 x 40 x 11 mm 90,00 €

Amplificador de señal digital para instalaciones basadas en pixels. Compatible con los programadores LB1-B, LB1 y LB8.
Digital signal amplifier for pixel based installations. Compatible with LB1-B, LB1 and LB8 programmers.



DMX-DIG

Diferido
Stand alone



DMX-DIG	140 x 65 x 40 mm	85,00 €
----------------	------------------	---------

Convertidor para controlar el número de escena y la velocidad del programador LB8 con señal DMX. También permite convertir la señal DMX en señal compatible con señal digital (SPI). Incluye adaptador 5V – AC/DC.
 Converter to control the scene number and speed of the LB8 programmer with DMX signal. It also allows to convert the DMX signal into signal compatible with Digital (SPI) signal. 5V – AC/DC adapter included.

DMR-LB8

Diferido
Stand alone



12V 24V

DMR-LB8	125 x 50 x 25 mm	89,70 €
----------------	------------------	---------

Accesorio para controlar el número de escena y la velocidad del programador LB8 con 4 pulsadores libres de carga (no incluidos).
 Converter to control the scene number and speed of the LB8 programmer with push-buttons without charge (not included).

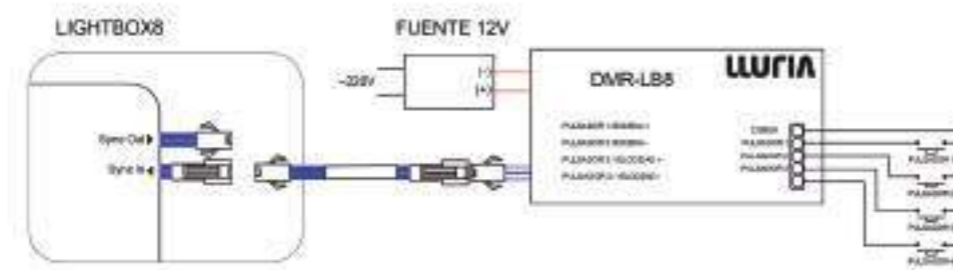

-Directo
-Live



LB-ART

Directo
Live

LB-ART1	Módulo Artnet 1 puerto Module Artnet 1 port	a cons. to cons.
LB-ART2	Módulo Artnet 2 puertos Module Artnet 2 ports	a cons. to cons.
LB-ART4	Módulo Artnet 4 puertos Module Artnet 4 ports	a cons. to cons.

Convertidor basado en el protocolo Artnet para controlar leds directamente con señal SPI sin necesidad de equipos adicionales. Permite controlar la instalación en directo. La conexión se realiza a través de la red Ethernet. Dispone de 1, 2 o 4 puertos dependiendo del modelo. Especialmente indicado para proyectos e instalaciones espectaculares.

Artnet protocol based converter to directly control LEDs with SPI signal without additional equipment. Allows you to control the live installation. The connection is made through the Ethernet network. It has 1, 2 or 4 ports depending on the model. Especially suitable for projects and spectacular installations.



LB-PC

Directo
Live

LB-PC	Ordenador Computer	a cons. to cons.
--------------	--------------------	---------------------

Ordenador personal para instalar software de control en directo para instalaciones con led. De dimensiones reducidas podrá ser portátil o mini pc sin pantalla para evitar manipulación por parte del personal no autorizado según proyecto.
Personal computer to install live control software for installations with led. Of small dimensions it can be portable or mini pc without screen to avoid manipulation by the unauthorized personnel according to project.



LB-SOFT

Directo
Live

LB-SOFT	Software para control en directo Software to live control	a cons. to cons.
----------------	--	---------------------

Software para controlar leds desde un ordenador convencional o portátil. Puede controlar decenas de miles de pixels. Dispone de multitud de combinaciones para generar escenas de una manera sencilla. Permite generar mapeados personalizados y programar una lista de reproducción de diferentes escenas.

Software to control leds from a conventional or portable computer. You can control tens of thousands of pixels. It has a multitude of combinations to generate scenes in a simple way. It allows you to generate custom maps and program a playlist of different scenes.

Sistemas operativos compatibles Supported Operating Systems:

Microsoft® Windows® 7
Microsoft® Windows® 8
Microsoft® Windows® 8.1
Microsoft® Windows® 10

Compatible con 32 bits y 64 bits Compatible with 32 bits and 64 bits

Requerimientos mínimos del sistema Minimum System Requirements:

2.0 GHz dual-core CPU
OpenGL 2.1 tarjeta gráfica graphics card
2 GB RAM
1 GB espacio libre en el disco duro free harddisk space
1280 x 768 resolución de pantalla screen resolution
Tarjeta de red Network card
Tarjeta de sonido Sound card

Iluminación dinámica
Dynamic lighting

Tira LED digital Digital LED strip

-Sistema de iluminación lineal Digital con diferentes grados Kelvin y colores.

-Digital linear lighting system with different Kelvin degrees and colors.

***Posibilidad de otros voltajes** Other voltages are available



- IP20
 - D. Moon
 - D. Titan
- IP67
 - D. Luxel
 - D. Luxel RGB

Iluminación dinámica
Dynamic lighting



D-MON-14,4

Moon



D-MON-14,4-27	● 2700K	1070 lm/m
D-MON-14,4-40	○ 4000K	1100 lm/m

Posibilidad de otros voltajes Other voltages are available

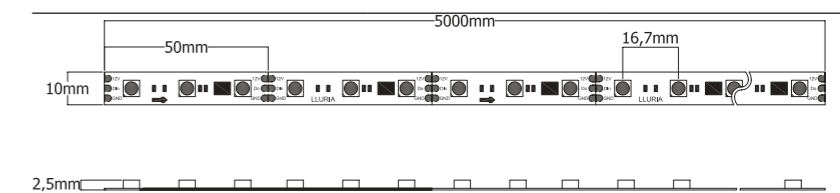

PVP € x m	PVP € x 5m
41,43 €	186,45 €

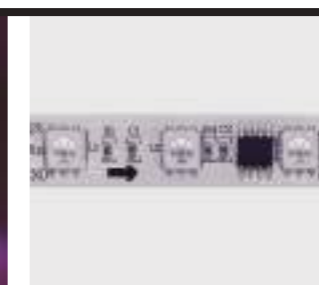

D-TTN-14,4

Titan RGB



D-TTN-14,4 ● RGB

Posibilidad de otros voltajes Other voltages are available

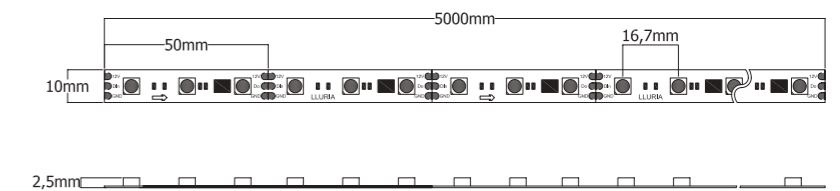

PVP € x m	PVP € x 5m
45,11 €	203,00 €

Iluminación dinámica Dynamic lighting

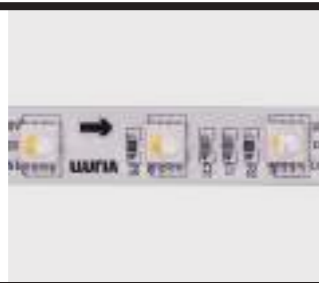

D-TTN-14,4

Titan **RGBW**

IP20
 12V
 4 n1
 3 LED/px
 20 px/m
 14,4 W/m

D-TTN-14,4-RGBW RGBW = RGB + 2700K

Posibilidad de otros voltajes Other voltages are available

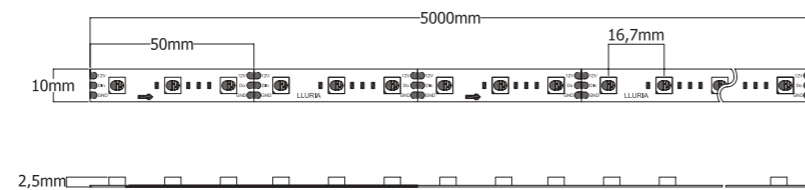

PVP
 € x m
 PVP
 € x 5m
 51,11 € 230,00 €

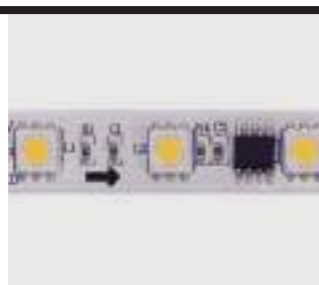

D-TTN-14,4

Titan **Triple White**

IP20
 12V
 3 n1
 3 LED/px
 20 px/m
 14,4 W/m

D-TTN-14,4-27-55-A Ambar Amber + 2700K + 5500K

Posibilidad de otros voltajes Other voltages are available

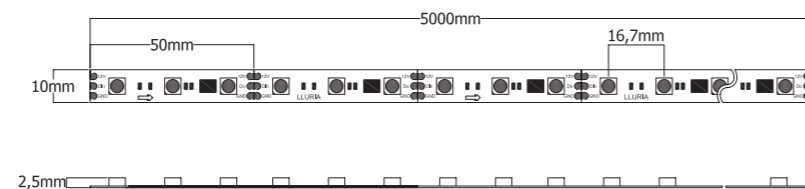

PVP
 € x m
 PVP
 € x 5m
 55,56 € 250,00 €

Iluminación dinámica Dynamic lighting



D-LXL-14,4

Luxel IP67

IP67
 12V
 3 LED/px
 20 px/m
 14,4 W/m

D-LXL-14,4-27 2700K 910 lm/m

D-LXL-14,4-40 4000K 960 lm/m

Posibilidad de otros voltajes Other voltages are available

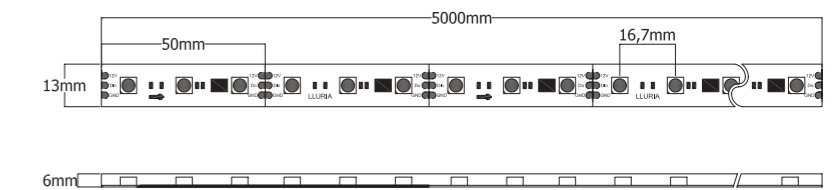

PVP
 € x m
 PVP
 € x 5m
 43,07 € 193,80 €



D-LXL-14,4

Luxel IP67 **RGB**

IP67
 12V
 3 n1
 3 LED/px
 20 px/m
 14,4 W/m

D-LXL-14,4 RGB RGB

Posibilidad de otros voltajes Other voltages are available

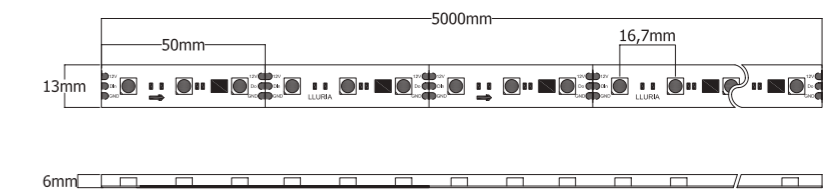

PVP
 € x m
 PVP
 € x 5m
 47,06 € 211,75 €

Iluminación dinámica Dynamic lighting

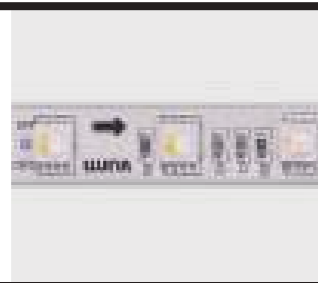

D-LXL-14,4

Luxel IP67 **RGBW**

IP67
 12V
 4 n1
 3 LED/px
 20 px/m
 14,4 W/m

D-LXL-14,4-RGBW RGBW = RGB + 2700K
Posibilidad de otros voltajes Other voltages are available

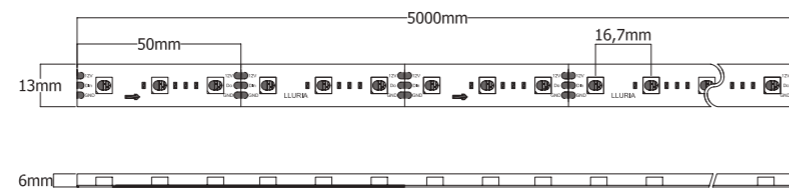

PVP
 € x m
 PVP
 € x 5m
 56,67 € 255,00 €



D-LXL-14,4

Luxel IP67 **Triple White**

IP67
 12V
 3 n1
 3 LED/px
 20 px/m
 14,4 W/m

D-LXL-14,4-27-55-A Ambar Amber + 2700K + 5500K
Posibilidad de otros voltajes Other voltages are available

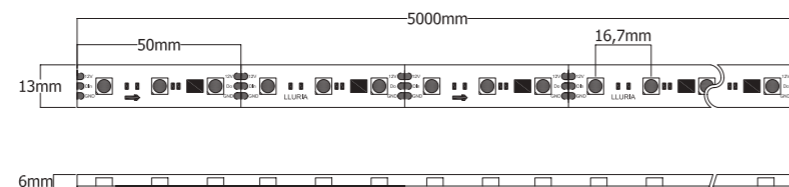

PVP
 € x m
 PVP
 € x 5m
 61,11 € 275,00 €

Iluminación dinámica Dynamic lighting

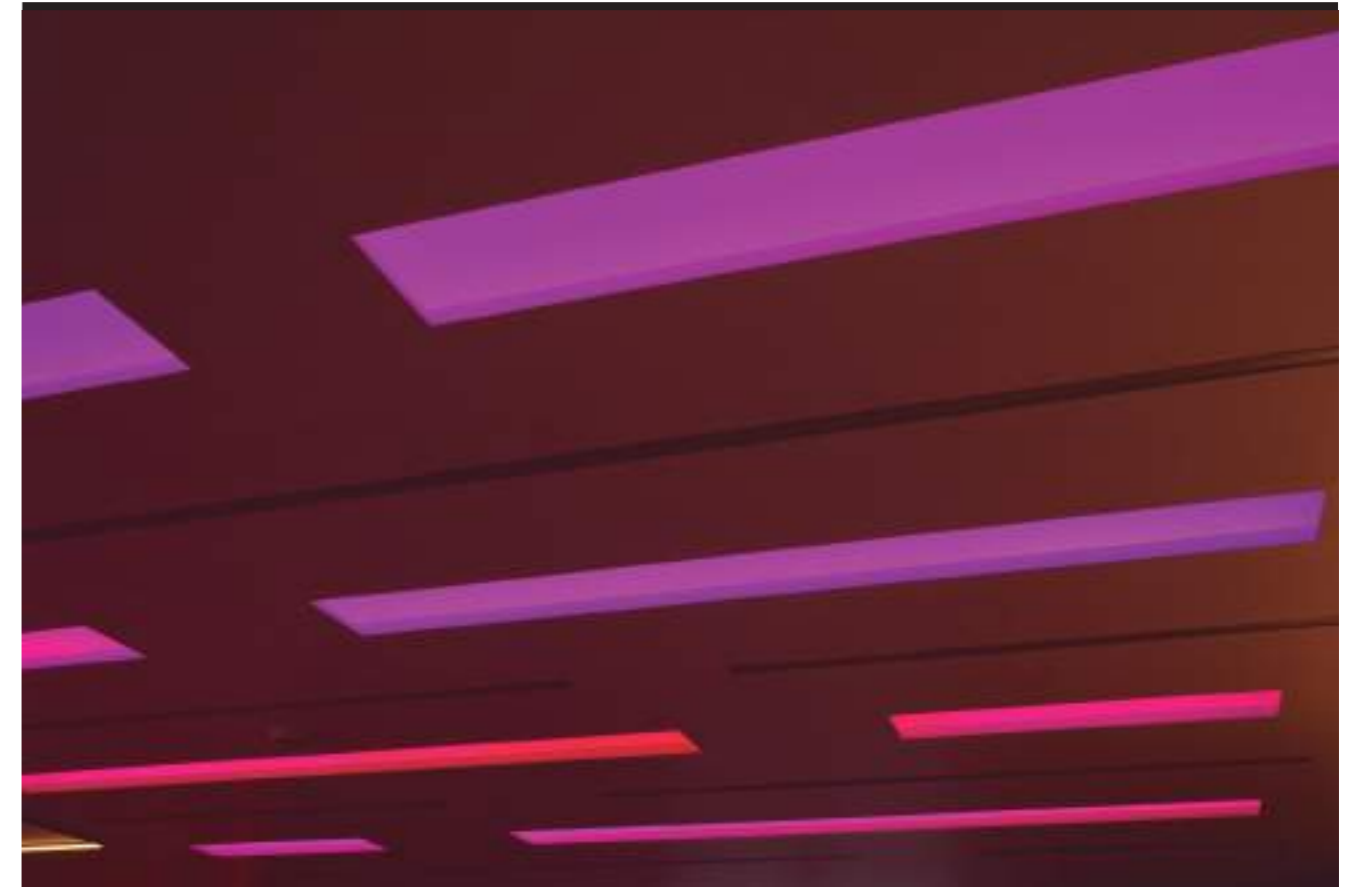

Show-room Lluria / Barcelona

Cableado y links Wiring and links

-Cables, links y conectores rápidos para hacer que la instalación sea mucho más sencilla.

-Cables, links and quick connectors to make the installation much easier.



Cableado y links Wiring and links



CT-MER-D+A

CT-MER-D+A	Link de datos + alimentación Data link + power	8,20€
------------	--	-------



CT-REF-A+

CT-REF-A+	Link alimentación Power link	8,20€
-----------	------------------------------	-------



CT-REF-AF

CT-REF-AF	Link alimentación final de línea Power link end line	5,00€
-----------	--	-------



CD-3H

CD-3H-0,5	Cable de alimentación y datos 0,5m Power wire and data 0,5m	11,00 €
CD-3H-2	Cable de alimentación y datos 2m Power wire and data 2m	21,00 €
CD-3H-5	Cable de alimentación y datos 5m Power wire and data 5m	27,00 €



CD-2H

CD-2H-0,5	Cable de alimentación 0,5m Power wire 0,5m	7,80 €
CD-2H-2	Cable de alimentación 2m Power wire 2m	17,90 €
CD-2H-5	Cable de alimentación 5m Power wire 5m	24,00 €



CD-SIN

CD-SIN-0,5	Cable de sincronización 0,5m Wire syncro 0,5m	8,00 €
CD-SIN-2	Cable de sincronización 2m Wire syncro 0,5m	18,00 €
CD-SIN-5	Cable de sincronización 5m Wire syncro 0,5m	24,00 €



D-C

		100m	1m
D-C2C	Cable de 2 hilos apantallado Shielded 2 wire cable	324,00 €	3,70€
D-C4C	Cable de 4 hilos apantallado Shielded 4 wire cable	540,00 €	6,00€



Kits

Los Kits incluyen

- ✓
- Fuente/s de alimentación
- Controlador/es
- Links y cableado de datos y de sincronización
- Tarjeta SD con las 8 programaciones estándar
- *Tira de LED Digital y perfil no incluidos

Kits include

- ✓
- Power supply /es
- Controller/s
- Links and data wiring and synchronization
- SD card with 8 standard settings
- *Digital LED Strip and profile not included



Kits



Proporcionamos una nueva y mejor facilidad técnica, desde la simplicidad, conexionado rápido y sencillo y la modularidad. Ejemplos de instalaciones hasta un máximo de 24 líneas de 24 metros de largo:

- Lineales: paralelas, foseados, bañador, estanterías, barras y mostradores.
- Matricial: Techos técnicos y decorativos.

Kits



We provide a new and better technical facility, from simplicity, fast and simple connection and modularity. Examples of installations up to a maximum of 24 lines of 24 meters in length:

- Linear: parallel, cove lighting, wall-washer, shelves, bars and counters.
- Matrix: Technical and decorative ceilings.

Estanterías
Shelves



Foseados
Cove lighting



Bañador de pared
Wall washer



Linea decorativa color o blanca
Decorative line color or white



Matriz decorativa (60x60)
Decorative matrix (60x60)

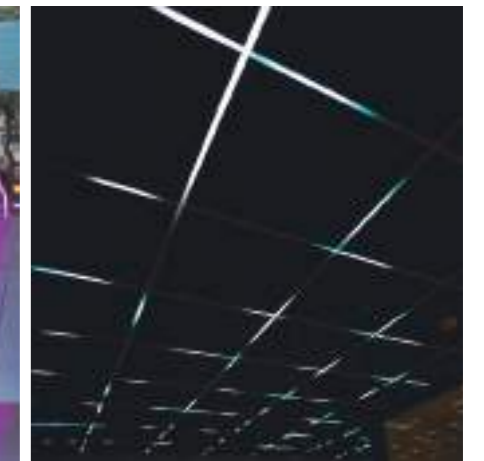

Iluminación dinámica Dynamic lighting

Modelos Kits dinámicos Disponemos de 3 familias Dynamic kits We have 3 models

Tira de LED Digital y perfil no incluidos

Digital LED Strip and profile not included



Kit Basic: Permite controlar hasta 10 metros de tira de LED Digital con un sencillo controlador. Incluye LB1-B, fuente de alimentación clase II, cableado y tarjeta SD.

Basic Kit: It allows controlling up to 10 meters of digital LED strip with a simple controller. LB1-B, power supply class II, wiring and SD card included.

K-B-W-5	Kit digital Basic led blanco, max. 5m	237,04 €
K-B-W-10	Kit digital Basic led blanco, max. 10m	289,60 €
K-B-RGB-5	Kit digital Basic led RGB, max. 5m	237,04 €
K-B-RGB-10	Kit digital Basic led RGB, max. 10m	289,60 €

Kit LB1: Controla hasta máx. 20 metros, pero con la posibilidad de sincronizar hasta 8 controladores para instalaciones más complejas. Incluye LB1, fuente de alimentación clase II, cableado y tarjeta SD.

Kit LB1: Controls up to max. 20 meters, but with the possibility of synchronizing up to 8 controllers for more complex installations. LB1, power supply class II, wiring and SD card included.

K-1-W-5	Kit digital LB1 led blanco, max. 5m	382,04 €
K-1-W-10	Kit digital LB1 led blanco, max. 10m	434,60 €
K-1-W-15	Kit digital LB1 led blanco, max. 15m	442,80 €
K-1-W-20	Kit digital LB1 led blanco, max. 20m	567,62 €
K-1-RGB-5	Kit digital LB1 led RGB, max. 5m	382,04 €
K-1-RGB-10	Kit digital LB1 led RGB, max. 10m	434,60 €
K-1-RGB-15	Kit digital LB1 led RGB, max. 15m	442,80 €
K-1-RGB-20	Kit digital LB1 led RGB, max. 20m	567,62 €

Kit LB8: Este sistema dispone de 8 puertos de salida de datos; lo que nos permite controlar 8x20 metros con cada LB8. Y, además, se pueden sincronizar varios aparatos. Incluye LB8, fuente de alimentación clase II, cableado y tarjeta SD

Kit LB8: This system has 8 data output ports; Allowing us to control 8x20 meters with each LB8. In addition, several devices can be synchronized. LB8, power supply class II, wiring and SD card included.

K-8-W-5	Kit digital LB8 led blanco, max. 5m por puerto	1.666,44 €
K-8-W-10	Kit digital LB8 led blanco, max. 10m por puerto	2.161,28 €
K-8-W-15	Kit digital LB8 led blanco, max. 15m por puerto	2.656,12 €
K-8-W-20	Kit digital LB8 led blanco, max. 20m por puerto	3.150,96 €
K-8-RGB-5	Kit digital LB8 led RGB, max. 5m por puerto	1.666,44 €
K-8-RGB-10	Kit digital LB8 led RGB, max. 10m por puerto	2.161,28 €
K-8-RGB-15	Kit digital LB8 led RGB, max. 15m por puerto	2.656,12 €
K-8-RGB-20	Kit digital LB8 led RGB, max. 20m por puerto	3.150,96 €

Iluminación dinámica Dynamic lighting



Luminaria Tesella Tesella lamp

-Tesella es un concepto de iluminación dinámica capaz de añadir distinción y personalidad a cualquier espacio. Su concepción modular y su contenido pre-configurado permite infinidad de composiciones adaptándose a la ubicación o forma deseada.

-Tesella is a dynamic lighting concept able of adding distinction and personality to any space. Its modular design and pre-configured content allows for a multitude of compositions adapting to the desired location or shape.

Tesella



Con un **diseño minimalista**, sin bordes, su construcción maximiza el área iluminada para convertir de manera sencilla una superficie en un elemento vivo que guíe las sensaciones que transmiten el espacio. Junto con el sistema de control **Lightbox**, resulta un **sistema plug&play**, tan sencillo de utilizar como de instalar. Tenemos modelos para instalar en paredes y techos tanto en superficie, como para empotrar y en suspensión. Compuesto por panel metálico, tira de LED Digital, difusor tensado mate y accesorios de montaje.

Tesella



With a **minimalist design**, borderless, its construction maximizes the lighted area to easily convert a surface into a living element that guides the sensations that transmit the space. Together with the **Lightbox** control system, a **plug&play system** is easy to use and easy to install. We have models to install on walls and ceilings both in surface, and for recess and pendant. Formed by metallic panel, LED digital strip, matt stretched diffuser and mounting accessories.

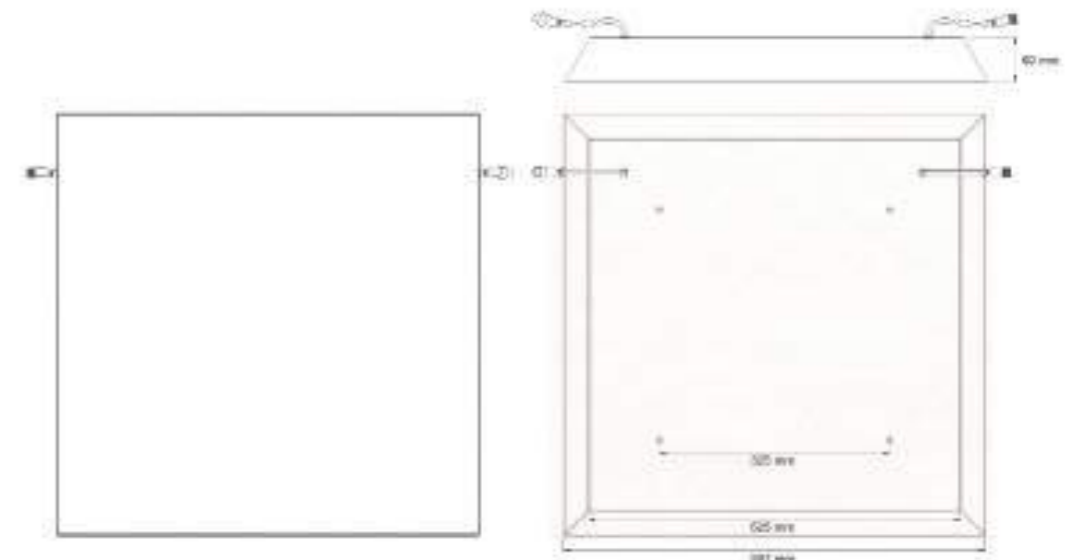

Modelos Tesella

Tesella models



TES-60X60-D-TTN-14.4	Panel 60x60 con led digital RGB 60x60 Panel, with RGB digital led	435,00 €
TES-60X60-D-TTN-14.4-T	Panel 60x60 de superficie con led digital RGB 60x60 Surface panel, with RGB digital led	450,00 €
TES-60X60-D-TTN-14.4-S	Panel 60x60 para suspensión con led digital RGB 60x60 Pendant panel, with RGB digital led	470,00 €
TES-60X60-D-MON-14.4	Panel 60x60 con led digital blanco 2700k 60x60 Panel, with white digital led 2700k	435,00 €
TES-60X60-D-MON-14.4-T	Panel 60x60 de superficie con led digital blanco 2700k 60x60 Surface panel, with white digital led 2700k	450,00 €
TES-60X60-D-MON-14.4-S	Panel 60x60 para suspensión con led digital blanco 2700k 60x60 Pendant panel, with white digital led 2700k	470,00 €

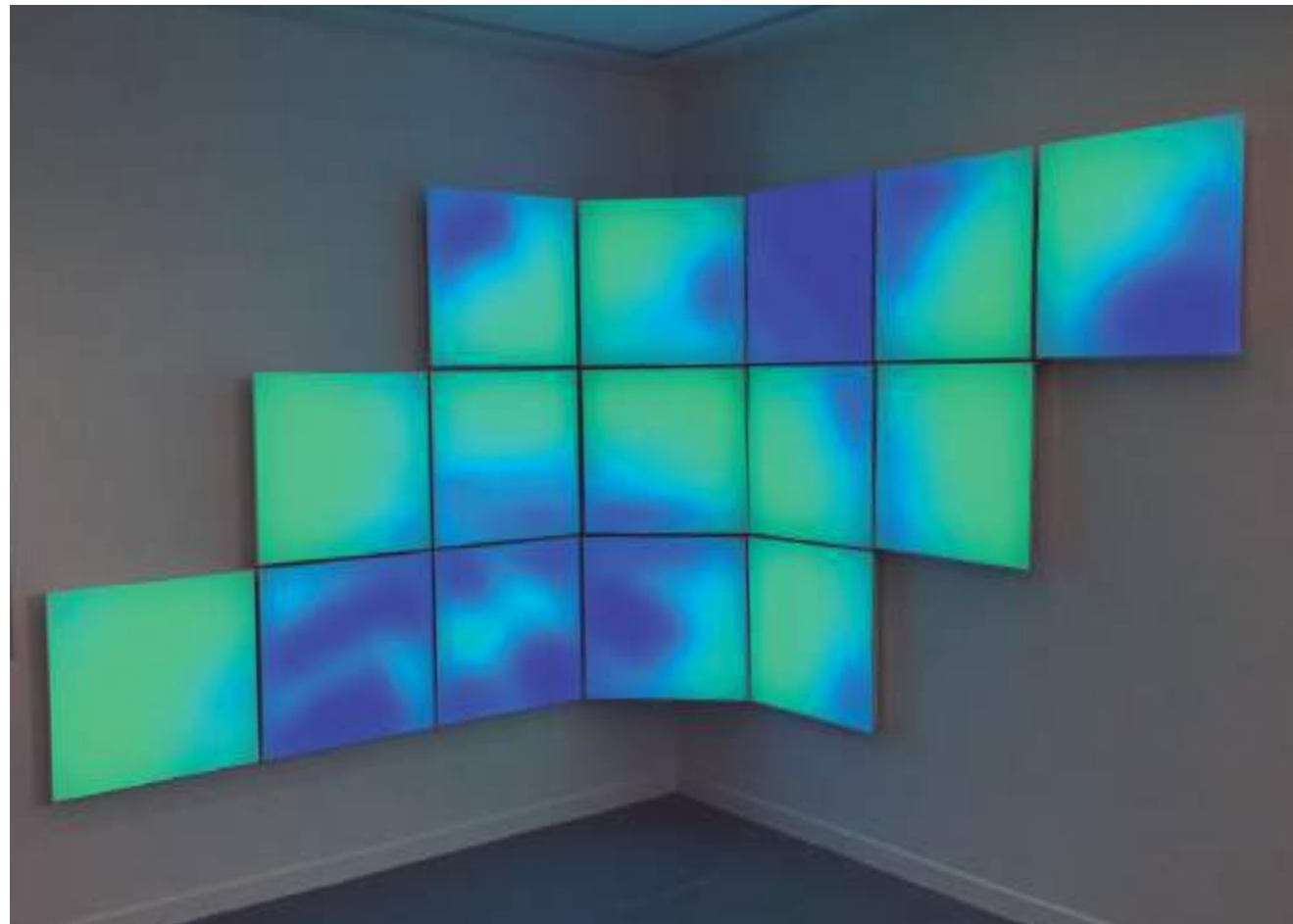

DMX

-Disponemos de una amplia gama de programadores y convertidores DMX aptos para cualquier aplicación dinámica LED multicolor.

-We have a wide range of DMX programmers and converters suitable for any dynamic multicolour LED application.



Equipos **DMX** para realizar instalaciones con este protocolo o en las que haya que incluir otras luminarias que funcionen con este tipo de señal.

DMX equipment for installations with this protocol or in which other luminaires that work with this type of signal.

**-Programadores
-Controllers**



PPT-DMX

Programadores
Controllers



PPT-DMX	86 x 86 x 10 mm	693,84 €
----------------	-----------------	----------

Programador DMX512, permite programar hasta 24 escenas dinámicas o estáticas mediante USB. Puede funcionar en directo o en diferido. Tiene 3 botones táctiles para seleccionar las escenas programadas, intensidad y colores. Puede controlar hasta 512 canales DMX. Compatible con cualquier luminaria DMX o driver led DMX. Incluye cable USB, software de control y adaptador de 5-12V AC/DC.
Controller DMX512, allows programming up to 24 dynamic or static scenes via USB. It can operate live or stand alone. It has 3 touch buttons to select the programmed scenes, intensity and colors. Can controller up to 512 DMX channels. Compatible with any DMX light or DMX led driver. Includes USB cable, control software and 5-12V AC / DC adapter.



LB-DMX

Programadores
Controllers



LB-DMX	132 x 70 x 20 mm	160,00 €
---------------	------------------	----------

Programador para instalaciones basadas señal DMX. Dispone de un puerto de salida de datos. Puede controlar hasta 170px RGB. Necesita tarjeta SD para su funcionamiento. Permite modificar número de escena y velocidad de reproducción. Se puede sincronizar con otros LB-DMX para instalaciones de mayor tamaño.
Programmer for DMX signal based installations. It has a data output port. It can control up to 170px RGB. Requires SD card for operation. It allows to modify scene number and playback speed. It can be synchronized with other LB-DMXs for larger installations.

-Convertidores

-Converters



DMX-DALI-PWM

Convertidor 3 canales
Converter 3 channels



DMX-DALI-PWM 110 x 70 x 23 mm 64,32 €

Convertidor compatible con las señales DMX512 y DALI. Posibilidad de seleccionar la dirección DMX mediante Switch. Funciona a 12 y a 24V. Dispone de 3 canales, máx. 144W.
Converter compatible with DMX512 and DALI signals. Possibility to select DMX address via Switch. It works to 12 and 24V. It has 3 channels, max. 144W.



DEC-DMX

Convertidor 4 canales
Converter 4 channels

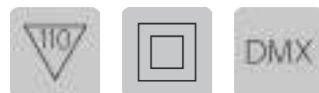

DEC-DMX 166 x 67 x 41mm 82,53 €

Convertidor compatible con la señal DMX512. Posibilidad de seleccionar la dirección DMX mediante Switch. Posibilidad de seleccionar con el Switch 10 escenas que incluyen cambios de color y colores fijos. Funciona a 12 y a 24V. Dispone de 4 canales, máx. 384W.
Converter compatible with DMX512 and DALI signals. Possibility to select DMX address via Switch. Possibility to select with the Switch 10 scenes that include color changes and fixed colors. It works to 12 and 24V. It has 3 channels, max. 144W.



LB-DEC-DMX-3

Convertidor 3 canales
Converter 3 channels



LB-DEC-DMX-3 54 x 28 x 11 mm 85,00 €

Convertidor compatible con la señal DMX512. La dirección DMX se graba con programador externo. Funciona a 12 y a 24V. Dispone de 3 canales, máx. 144W.
Converter compatible with DMX512 signal. DMX address is recorded with external programmer. It works to 12 and 24V. It has 3 channels, max. 144W.



Esquemas y
recomendaciones
*Schemes and
recommendations*

Esquemas y recomendaciones

Schemes & recommendations

Respete las **distancias máximas** de las tiras de led conectadas en serie para evitar caídas de tensión y variaciones en la intensidad lumínica. Respect the **maximum lengths** of led strip connected in series to avoid drops voltage and variations in light intensity.



Tiras de led monocolor Single-colour led

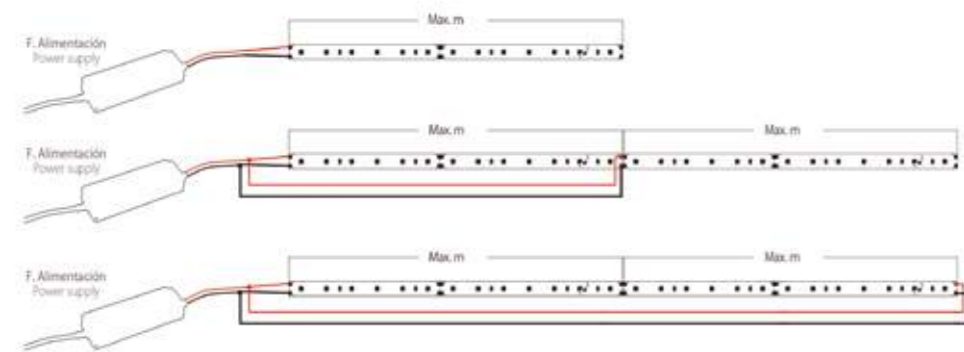

	Max. m
Para tiras de led hasta 20W/m For led strip up to 20W/m	10 m
Para tiras de led hasta 45W/m For led strip up to 45W/m	5 m
Para tiras de led superiores a 45W/m For led strip higher than 45W/m	3 m

Tiras de led con más de un color o CCT Led strip with more than one color or CCT

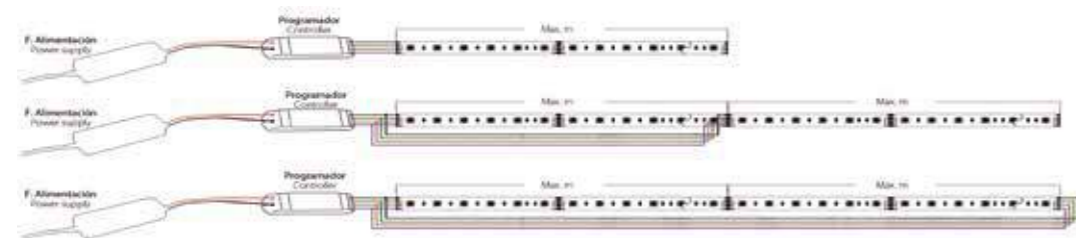

	Max. m
Para tiras de led hasta 15W/m For led strip up to 15W/m	10 m
Para tiras de led hasta 20W/m For led strip up to 20W/m	5 m

Esquemas y recomendaciones

Schemes & recommendations

Sección cable Cable section

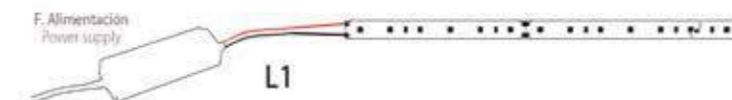

	L1 Sección del cable Section of cable L1		
Distancia Distance	≤ 5 m	≤ 15 m	≤ 25 m
Para tiras de led hasta 15W/m For led strip up to 15W/m	0.5 mm ²	1 mm ²	1.5 mm ²
Para tiras de led hasta 45W/m For led strip up to 45W/m	1.5 mm ²	2.5 mm ²	4 mm ²
Para tiras de led superiores a 45W/m For led strip higher than 45W/m	2.5 mm ²	4 mm ²	6 mm ²

Tiras de led con más de un color o CCT Led strip with more than one color or CCT

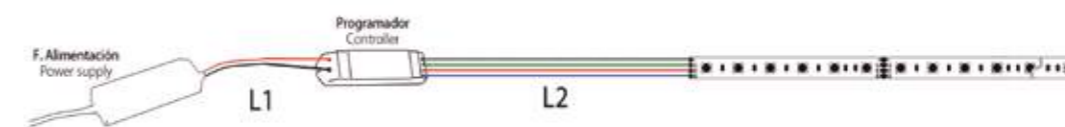

	L1 y L2 Sección del cable Section of cable L1 and L2		
Distancia Distance	≤ 5 m	≤ 15 m	≤ 25 m
Para tiras de led hasta 15W/m For led strip up to 15W/m	0.5 mm ²	1 mm ²	1.5 mm ²
Para tiras de led superiores a 20W/m For led strip higher than 20W/m	0.5 mm ²	1.5 mm ²	2.5 mm ²

Advertencias

Vigile al manipular los cables para evitar daños en las soldaduras. No doble la tira de led para adaptarla a radios o ángulos pronunciados. Si manipula la tira de led, no olvide sellar los tramos para mantener la estanqueidad. Con el fin de garantizar la vida del led, es obligatorio colocarlo sobre una superficie que disipe el calor que generan. Los picos de tensión pueden causar daños. Si se utiliza difusor con el perfil disipador, puede haber variaciones en la temperatura de color.

Warnings

Caution when handling cables to avoid damage to the welds. Do not bend the led strip to adapt them to sharp radius or angle. If you manipulate the LED strip, do not forget to seal the sections to maintain the tightness. To ensure the life of the LED, it is request to place on a surface that dissipate the heat they generate. The voltage surges can cause damage. If diffuser is used with the dissipating profile, there may be variations in the color temperature.

Resumen condiciones generales de venta



1. Presupuestos

Los presupuestos tendrán una validez máxima de 30 días naturales, desde la fecha de su emisión. La aceptación del mismo, deberá ser firmada (aprobada por mail) por el cliente para poder emitir el correspondiente pedido.

2. Pedidos

Los pedidos, deberán realizarse por fax o correo electrónico. No se aceptan pedidos telefónicos. No se podrán anular pedidos de materiales fabricados a medida.

3. Transportes

El cliente tiene la obligación de revisar el número de bultos, y si el embalaje está en buenas condiciones; anotando la incidencia en el albarán del transportista y comunicándolo a fábrica antes de las 24 horas siguientes a la recepción del pedido. Entonces se abrirá expediente de incidencia. En España (menos Canarias, Catalunya, Ceuta y Melilla) exención de portes por pedido igual o superior a 300€ de base imponible, si no, se cobrarán 10€ en factura. En Catalunya exención a partir de 200€. A Canarias, Ceuta y Melilla siempre portes debidos.

4. Devoluciones de material

No se aceptarán devoluciones transcurridos 30 días desde la entrega de material. No se aceptará devolución alguna de materiales realizados a medida. En caso de material no manipulado y en funcionamiento: se acepta la devolución siempre y cuando el material esté en perfecto estado, en su embalaje original y tras su revisión por el Departamento Técnico. Se aplicará un demérito del 20%. De igual manera, con el material sobrante de obra. Para autorizar una devolución, deberán solicitarnos número de autorización (AD) por fax o correo electrónico, relacionando el material con nuestras referencias y número de albarán o factura. No se aceptará material que no llegue acompañado de la autorización de devolución (AD).

5. Incidencias y Reposiciones

Cuando ocurra una incidencia, el cliente, en primer lugar, deberá remitirnos imágenes del producto y de su instalación. Las reposiciones, por cualquier motivo, siempre se enviarán con cargo al cliente. Una vez analizado, se procederá o no a su abono.

6. Facturación

Todas nuestras ventas están aseguradas. Asesoría de Iluminación, S.L. se reserva el derecho a solicitar el pago por adelantado en caso de que la aseguradora no autorice la transacción comercial.

7. Formas de pago

Según normativa vigente. En caso de impagados se cobrarán los gastos financieros (gasto de devolución, intereses de demora, etc.). Se aplicará un 2% de descuento adicional en caso de pronto pago.

8. Garantía

Nuestros productos tienen una garantía de 2 a 7 años (a consultar), contando a partir de la fecha del albarán de entrega. La garantía queda limitada a la reparación o sustitución de materiales iguales o equivalentes. No incluyen costes de reposición (transporte) o de instalación / desinstalación del producto.

9. Exclusiones

Quedará fuera de garantía, todo material manipulado por personal no autorizado por la empresa. Así como el instalado en condiciones técnicas o térmicas no apropiadas (ventilación insuficiente, exposición directa a fuentes de calor e intemperie cuando el producto requiera protección). Y/o mal instaladas. Para la resolución de cualquier litigio, la parte compradora renuncia a su propio fuero y se somete a los Tribunales que corresponden al domicilio fiscal de Asesoría de Iluminación, SLU. Empresa registrada en REIRAAE (nº3917) en cumplimiento con RD/208/2005 sobre Gestión de RAEE.

10. Productos

Lluria se reserva el derecho de modificar, en cualquier momento y sin previo aviso, las características técnicas y medidas de los productos que aparecen en este catálogo.

Summary general terms of sale



1. Budgets

The budgets will have a maximum validity of 30 calendar days, from the date of its issuance. The acceptance of the same, must be signed (approved by mail) by the client to be able to issue the corresponding order.

2. Orders

Orders must be made by fax or email. Phone orders are not accepted. You cannot cancel orders for materials made to measure.

3. Transportation

The customer is required to check the number of packages, and if the packaging is in good condition; Noting the incident on the delivery note of the carrier and communicating it to the factory within 24 hours of receipt of the order. Then an incident file will be opened. In Spain (except the Canary Islands, Catalonia, Ceuta and Melilla) exemption of freight by order equal or superior to € 300 of taxable base, if not, will be charged € 10 in invoice. In Catalonia exemption from 200 €. To the Canary Islands, Ceuta and Melilla always postage due.

4. Material returns

Returns will not be accepted after 30 days from the delivery of material. No return of custom made materials will be accepted. In case of unmanipulated and working material: the return is accepted as long as the material is in perfect condition, in its original packaging and after its revision by the Technical Department. A demerit of 20% will apply. The same with the surplus material of work. To authorize a return, you must request an authorization number (AD) by fax or email, relating the material with our references and bill of lading or invoice number. Material that does not arrive accompanied by the return authorization (AD) will not be accepted.

5. Incident and Repositions

When an incident occurs, the customer, in the first place, must send us images of the product and its installation. Replacements, for any reason, will always be sent with charge to the customer. Once analyzed, the payment will be made or not.

6. Billing

All our sales are insured. Asesoría de Iluminación, S.L. reserves the right to request the payment in advance in case the insurer does not authorize the commercial transaction.

7. Payment Methods

According to current legislation. In case of non-payment, the financial expenses (refund expense, late fees, etc.) will be charged. An additional 2% discount will apply in case of prepayment

8. Warranty

Our products have a warranty of 2 to 7 years (to consult), counting from the date of the delivery note. The warranty is limited to the repair or replacement of equal or equivalent materials. They do not include replacement costs (transportation) or installation / uninstallation of the product.

9. Exclusions

It will be out of warranty, all material manipulated by personnel not authorized by the company. As well as installed in inappropriate technical or thermal conditions (insufficient ventilation, direct exposure to heat sources and weathering when the product requires protection). And / or badly installed. For the resolution of any litigation, the buying party waives its own jurisdiction and is submitted to the Courts that correspond to the fiscal address of Asesoría de Iluminación, SLU. Company registered in REIRAAE (nº 3917) in compliance with RD / 208/2005 on WEEE Management.

10. Products

Lluria reserves the right to modify, at any time and without previous notice, the technical characteristics and measures of the products that appear in this catalog.

Lista de precios Price list

Ref.	PVP	25 Rollos 25 Reel	50 Rollos 50 Reel	Pág. P.	Ref.	PVP	Pág. P.
CMT-9,6-27-24	112,27 €	107,53 €	102,90 €	40	DIF-STR18-T	24,74 €	95
CMT-9,6-27-24/M	26,42 €	25,30 €	24,21 €	40	DIF-STR18-T/M	13,74 €	95
CMT-9,6-40-24	112,27 €	107,53 €	102,90 €	40	DIF-STR19-O	a cons.	96
CMT-9,6-40-24/M	26,42 €	25,30 €	24,21 €	40	DIF-STR20-M	a cons.	97
CMT-9,6-55-24	112,27 €	107,53 €	102,90 €	40	DIF-STR20-M/M	a cons.	97
CMT-9,6-55-24/M	26,42 €	25,30 €	24,21 €	40	DIF-STR2-15	19,95 €	80
C-RGB	1,30 €			34	DIF-STR2-15/M	11,08 €	80
CR-MON-10	0,70 €			33	DIF-STR2-30	13,23 €	80
CR-MON-8	0,70 €			33	DIF-STR2-30/M	7,35 €	80
CR-RGB	0,90 €			34	DIF-STR2-60	13,23 €	80
CT-MER-D+A	8,20 €			165	DIF-STR2-60/M	7,35 €	80
CT-REF-A+	8,20 €			165	DIF-STR2-90	13,23 €	80
CT-REF-AF	5,00 €			165	DIF-STR2-90/M	7,35 €	80
D-C2C	324,00 €			165	DIF-STR2-AS	21,11 €	80
D-C2C/M	3,70 €			165	DIF-STR2-AS/M	11,73 €	80
D-C4C	540,00 €			165	DIF-STR2D-15	19,95 €	81
D-C4C/M	6,00 €			165	DIF-STR2D-15/M	11,08 €	81
DEC-DMX	82,53 €			176	DIF-STR2D-30	13,23 €	81
DEL-19,2-30-24	214,24 €			72	DIF-STR2D-30/M	7,35 €	81
DEL-19,2-30-24/M	47,61 €			72	DIF-STR2D-60	13,23 €	81
DIF-STR10-M	6,01 €			87	DIF-STR2D-60/M	7,35 €	81
DIF-STR10-M/M	3,34 €			87	DIF-STR2D-90	13,23 €	81
DIF-STR11-O	6,34 €			88	DIF-STR2D-90/M	7,35 €	81
DIF-STR11-O/M	3,52 €			88	DIF-STR2D-AS	21,11 €	81
DIF-STR12-M	13,17 €			89	DIF-STR2D-AS/M	11,73 €	81
DIF-STR12-M/M	7,32 €			89	DIF-STR2D-M	8,82 €	81
DIF-STR12-T	12,37 €			89	DIF-STR2D-M/M	4,90 €	81
DIF-STR12-T/M	6,87 €			89	DIF-STR2D-T	7,85 €	81
DIF-STR14-O	6,34 €			90	DIF-STR2D-T/M	4,36 €	81
DIF-STR14-O/M	3,52 €			90	DIF-STR2-M	8,82 €	80
DIF-STR14-T	5,88 €			90	DIF-STR2-M/M	4,90 €	80
DIF-STR14-T/M	3,27 €			90	DIF-STR2-T	7,85 €	80
DIF-STR15-O	49,67 €			92	DIF-STR2-T/M	4,36 €	80
DIF-STR15-O/M	27,59 €			92	DIF-STR3-30	13,23 €	82
DIF-STR16-O	5,75 €			93	DIF-STR3-30/M	7,35 €	82
DIF-STR16-O/M	3,19 €			93	DIF-STR3-M	6,01 €	82
DIF-STR17-30	13,23 €			94	DIF-STR3-M/M	3,34 €	82
DIF-STR17-30/M	7,35 €			94	DIF-STR3-O	6,01 €	82
DIF-STR17-O	6,01 €			94	DIF-STR3-O/M	3,34 €	82
DIF-STR17-O/M	3,34 €			94	DIF-STR3-T	4,33 €	82
DIF-STR17-T	4,33 €			94	DIF-STR3-T/M	2,40 €	82
DIF-STR17-T/M	2,40 €			94	DIF-STR4-30	13,23 €	83
DIF-STR18-M	26,34 €			95	DIF-STR4-30/M	7,35 €	83
DIF-STR18-M/M	14,63 €			95	DIF-STR4-M	6,01 €	83

Lista de precios Price list

Ref.	PVP	Pág. P.	Ref.	PVP	Pág. P.
DIF-STR4-M/M	3,34 €	83	DIF-STR7-M/M	3,34 €	85
DIF-STR4-O	6,01 €	83	DIF-STR7-T	4,33 €	85
DIF-STR4-O/M	3,34 €	83	DIF-STR7-T/M	2,40 €	85
DIF-STR4-T	4,33 €	83	DIF-STR9-M	7,06 €	86
DIF-STR4-T/M	2,40 €	83	DIF-STR9-M/M	3,92 €	86
DIF-STR51-30	13,23 €	106	DIF-STR9-T	6,95 €	86
DIF-STR51-30/M	7,35 €	106	DIF-STR9-T/M	3,86 €	86
DIF-STR51-M	6,01 €	106	DIF-STRTS-M	6,00 €	101
DIF-STR51-M/M	3,34 €	106	DIF-STRTS-M/M	3,33 €	101
DIF-STR51-O	6,01 €	106	DIF-STRTS-O	6,00 €	101
DIF-STR51-O/M	3,34 €	106	DIF-STRTS-O/M	3,33 €	101
DIF-STR51-T	4,33 €	106	DIF-STRTS-T	4,33 €	101
DIF-STR51-T/M	2,40 €	106	DIF-STRTS-T/M	2,41 €	101
DIF-STR52-30	13,23 €	107	D-LXL-14,4-27	193,80 €	161
DIF-STR52-30/M	7,35 €	107	D-LXL-14,4-27/M	43,07 €	161
DIF-STR52-M	6,01 €	107	D-LXL-14,4-27-55-A	275,00 €	162
DIF-STR52-M/M	3,34 €	107	D-LXL-14,4-27-55-A/M	61,11 €	162
DIF-STR52-O	6,01 €	107	D-LXL-14,4-40	193,80 €	161
DIF-STR52-O/M	3,34 €	107	D-LXL-14,4-40/M	43,07 €	161
DIF-STR52-T	4,33 €	107	D-LXL-14,4-RGB	211,75 €	161
DIF-STR52-T/M	2,40 €	107	D-LXL-14,4-RGB/M	47,06 €	161
DIF-STR54-M	6,01 €	108	D-LXL-14,4-RGBW	255,00 €	162
DIF-STR54-M/M	3,34 €	108	D-LXL-14,4-RGBW/M	56,67 €	162
DIF-STR54-O	6,34 €	108	D-MON-14,4-27	186,45 €	159
DIF-STR54-O/M	3,52 €	108	D-MON-14,4-27/M	41,43 €	159
DIF-STR54-T	4,33 €	108	D-MON-14,4-40	186,45 €	159
DIF-STR54-T/M	2,40 €	108	D-MON-14,4-40/M	41,43 €	159
DIF-STR55-M	13,17 €	109	DMPx	52,45 €	127
DIF-STR55-M/M	7,32 €	109	DMR-0-10-75	83,79 €	137
DIF-STR55-T	12,37 €	109	DMR-150	94,76 €	128
DIF-STR55-T/M	6,87 €	109	DMR-75	65,92 €	128
DIF-STR56-O	6,34 €	110	DMR-DA	83,58 €	137
DIF-STR56-O/M	3,52 €	110	DMR-KNX-3	347,36 €	137
DIF-STR56-T	5,88 €	110	DMR-KNX-4	422,33 €	138
DIF-STR56-T/M	3,27 €	110	DMR-KNX-DIN4	522,29 €	138
DIF-STR6-30	13,23 €	84	DMR-LB8	89,70 €	154
DIF-STR6-30/M	7,35 €	84	DMR-MINI	21,30 €	129
DIF-STR6-M	6,01 €	84	DMR-SMART	81,06 €	130
DIF-STR6-M/M	3,34 €	84	DMR-T2x	60,67 €	130
DIF-STR6-O	6,01 €	84	DMR-Tx	52,45 €	127
DIF-STR6-O/M	3,34 €	84	DMX-DALI-PWM	64,32 €	176
DIF-STR6-T	4,33 €	84	DMX-DIG	85,00 €	154
DIF-STR6-T/M	2,40 €	84	D-TTN-14,4	203,00 €	159
DIF-STR7-M	6,01 €	85	D-TTN-14,4/M	45,11 €	159

Lista de precios Price list

Ref.	PVP	Pág. P.	Ref.	PVP	Pág. P.
STR-15-N/M	12,37 €	92	STR-18-DMT-B	88,54 €	95
STR-15-TP	6,87 €	92	STR-18-DMT-B/M	49,19 €	95
STR-16-A	18,06 €	93	STR-18-DMT-N	88,54 €	95
STR-16-A/M	10,03 €	93	STR-18-DMT-N/M	49,19 €	95
STR-16-DO	24,10 €	93	STR-18-DT	81,34 €	95
STR-16-DO/M	13,39 €	93	STR-18-DT/M	45,19 €	95
STR-16-TP	1,50 €	93	STR-18-DT-B	87,74 €	95
STR-17-30	35,60 €	94	STR-18-DT-B/M	48,74 €	95
STR-17-30/M	19,78 €	94	STR-18-DT-N	87,74 €	95
STR-17-30-B	39,60 €	94	STR-18-DT-N/M	48,74 €	95
STR-17-30-B/M	22,00 €	94	STR-18-E	9,50 €	95
STR-17-30-N	39,60 €	94	STR-18-N	63,00 €	95
STR-17-30-N/M	22,00 €	94	STR-18-N/M	35,00 €	95
STR-17-A	22,37 €	94	STR-18-TP	12,50 €	95
STR-17-A/M	12,43 €	94	STR-18-TP-B	13,80 €	95
STR-17-B	26,37 €	94	STR-18-TP-N	13,80 €	95
STR-17-B/M	14,50 €	94	STR-18-U	8,10 €	95
STR-17-CL	0,79 €	94	STR-19-CL	a cons.	96
STR-17-DT	24,83 €	94	STR-19-DO	a cons.	96
STR-17-DT/M	13,80 €	94	STR-19-TP	a cons.	96
STR-17-DT-B	30,08 €	94	STR-19-TPT	a cons.	96
STR-17-DT-B/M	16,71 €	94	STR-19-U	a cons.	96
STR-17-DT-N	37,92 €	94	STR20-1/4-1	a cons.	97
STR-17-DT-N/M	20,86 €	94	STR20-1/4-2	a cons.	97
STR-17-N	26,37 €	94	STR20-1/4-3	a cons.	97
STR-17-N/M	14,50 €	94	STR-20-DM	a cons.	97
STR-17-TP-D	2,20 €	94	STR-20-IO	a cons.	97
STR-17-TP-D-B	2,30 €	94	STR-20-TP	a cons.	97
STR-17-TP-D-N	2,30 €	94	STR-20-U	a cons.	97
STR-17-TP-I	2,20 €	94	STR-2-15	32,45 €	80
STR-17-TP-I-B	2,30 €	94	STR-2-15/M	18,03 €	80
STR-17-TP-I-N	2,30 €	94	STR-2-30	25,73 €	80
STR-18-A	55,00 €	95	STR-2-30/M	14,29 €	80
STR-18-A/M	30,56 €	95	STR-2-60	25,73 €	80
STR-18-B	63,00 €	95	STR-2-60/M	14,29 €	80
STR-18-B/M	35,00 €	95	STR-2-90	25,73 €	80
STR-18-DM	82,94 €	95	STR-2-90/M	14,29 €	80
STR-18-DM/M	46,08 €	95	STR-2-A	12,50 €	80
STR-18-DM-B	89,34 €	95	STR-2-A/M	6,94 €	80
STR-18-DM-B/M	49,63 €	95	STR-2-AS	33,60 €	80
STR-18-DM-N	89,34 €	95	STR-2-AS/M	18,67 €	80
STR-18-DM-N/M	49,63 €	95	STR-2-CL	0,79 €	80
STR-18-DMT	80,54 €	95	STR-2D-15	41,96 €	81
STR-18-DMT/M	44,74 €	95	STR-2D-15/M	23,31 €	81

Lista de precios Price list

Ref.	PVP	Pág. P.	Ref.	PVP	Pág. P.
STR-2D-30	35,24 €	81	STR-3-DO-N/M	12,78 €	82
STR-2D-30/M	19,58 €	81	STR-3-DT	14,91 €	82
STR-2D-60	35,24 €	81	STR-3-DT/M	8,28 €	82
STR-2D-60/M	19,58 €	81	STR-3-DT-B	20,16 €	82
STR-2D-90	35,24 €	81	STR-3-DT-B/M	11,20 €	82
STR-2D-90/M	19,58 €	81	STR-3-DT-N	20,16 €	82
STR-2D-A	23,00 €	81	STR-3-DT-N/M	11,20 €	82
STR-2D-A/M	12,65 €	81	STR-3-N	14,07 €	82
STR-2D-AS	43,11 €	81	STR-3-N/M	7,82 €	82
STR-2D-AS/M	23,95 €	81	STR-3-TP	0,82 €	82
STR-2D-CL	0,79 €	81	STR-3-TP-B	0,98 €	82
STR-2D-CLB	3,75 €	81	STR-3-TP-N	0,98 €	82
STR-2D-DM	30,87 €	81	STR-3-TPT	0,82 €	82
STR-2D-DM/M	17,15 €	81	STR-3-TPT-B	0,98 €	82
STR-2D-DT	29,82 €	81	STR-3-TPT-N	0,98 €	82
STR-2D-DT/M	16,57 €	81	STR-4-30	28,09 €	83
STR-2-DM	21,32 €	80	STR-4-30/M	15,61 €	83
STR-2-DM/M	11,84 €	80	STR-4-30-B	30,50 €	83
STR-2-DT	20,35 €	80	STR-4-30-B/M	16,95 €	83
STR-2-DT/M	11,31 €	80	STR-4-30-N	30,50 €	83
STR-2-DT-TP	0,95 €	81	STR-4-30-N/M	16,95 €	83
STR-2-TP	0,95 €	80	STR-4-A	14,86 €	83
STR-3-30	24,47 €	82	STR-4-A/M	9,60 €	83
STR-3-30/M	13,59 €	82	STR-4-B	17,27 €	83
STR-3-30-B	27,30 €	82	STR-4-B/M	9,60 €	83
STR-3-30-B/M	15,17 €	82	STR-4-CL	0,85 €	83
STR-3-30-N	27,30 €	82	STR-4-DM	20,95 €	83
STR-3-30-N/M	15,17 €	82	STR-4-DM/M	11,64 €	83
STR-3-A	11,24 €	82	STR-4-DM-B	26,20 €	83
STR-3-A/M	6,18 €	82	STR-4-DM-B/M	14,55 €	83
STR-3-B	14,07 €	82	STR-4-DM-N	26,20 €	83
STR-3-B/M	7,82 €	82	STR-4-DM-N/M	14,55 €	83
STR-3-CL	0,85 €	82	STR-4-DO	20,95 €	83
STR-3-DM	17,75 €	82	STR-4-DO/M	11,64 €	83
STR-3-DM/M	9,86 €	82	STR-4-DO-B	26,20 €	83
STR-3-DM-B	23,00 €	82	STR-4-DO-B/M	14,55 €	83
STR-3-DM-B/M	12,78 €	82	STR-4-DO-N	26,20 €	83
STR-3-DM-N	23,00 €	82	STR-4-DO-N/M	14,55 €	83
STR-3-DM-N/M	12,78 €	82	STR-4-DT	18,53 €	83
STR-3-DO	17,75 €	82	STR-4-DT/M	10,30 €	83
STR-3-DO/M	9,86 €	82	STR-4-DT-B	24,83 €	83
STR-3-DO-B	23,00 €	82	STR-4-DT-B/M	13,80 €	83
STR-3-DO-B/M	12,78 €	82	STR-4-DT-N	24,83 €	83
STR-3-DO-N	23,00 €	82	STR-4-DT-N/M	13,80 €	83

Lista de precios Price list

Ref.	PVP	Pág. P.	Ref.	PVP	Pág. P.
STR-4-N	17,27 €	83	STR-52-30-B	30,92 €	107
STR-4-N/M	8,25 €	83	STR-52-30-B/M	17,18 €	107
STR-4-TP	0,88 €	83	STR-52-30-N	30,92 €	107
STR-4-TP-B	1,05 €	83	STR-52-30-N/M	17,18 €	107
STR-4-TP-N	1,05 €	83	STR-52-A	15,28 €	107
STR-4-TPT	0,88 €	83	STR-52-A/M	8,40 €	107
STR-4-TPT-B	1,05 €	83	STR-52-B	17,69 €	107
STR-4-TPT-N	1,05 €	83	STR-52-B/M	9,83 €	107
STR-50	20,15 €	105	STR-52-DM	21,37 €	107
STR-51-30	24,89 €	106	STR-52-DM/M	11,87 €	107
STR-51-30/M	13,83 €	106	STR-52-DM-B	26,62 €	107
STR-51-30-B	27,72 €	106	STR-52-DM-B/M	14,79 €	107
STR-51-30-B/M	15,40 €	106	STR-52-DM-N	26,62 €	107
STR-51-30-N	27,72 €	106	STR-52-DM-N/M	14,79 €	107
STR-51-30-N/M	15,40 €	106	STR-52-DO	21,37 €	107
STR-51-A	11,66 €	106	STR-52-DO/M	11,87 €	107
STR-51-A/M	6,45 €	106	STR-52-DO-B	26,62 €	107
STR-51-B	14,49 €	106	STR-52-DO-B/M	14,79 €	107
STR-51-B/M	8,05 €	106	STR-52-DO-N	26,62 €	107
STR-51-DM	18,17 €	106	STR-52-DO-N/M	14,79 €	107
STR-51-DM/M	10,09 €	106	STR-52-DT	18,95 €	107
STR-51-DM-B	23,42 €	106	STR-52-DT/M	10,53 €	107
STR-51-DM-B/M	13,01 €	106	STR-52-DT-B	25,25 €	107
STR-51-DM-N	23,42 €	106	STR-52-DT-B/M	14,03 €	107
STR-51-DM-N/M	13,01 €	106	STR-52-DT-N	25,25 €	107
STR-51-DO	18,17 €	106	STR-52-DT-N/M	14,03 €	107
STR-51-DO/M	10,09 €	106	STR-52-N	17,69 €	107
STR-51-DO-B	23,42 €	106	STR-52-N/M	9,83 €	107
STR-51-DO-B/M	13,01 €	106	STR-52-TPT	0,88 €	107
STR-51-DO-N	23,42 €	106	STR-52-TPT-B	1,05 €	107
STR-51-DO-N/M	13,01 €	106	STR-52-TPT-N	1,05 €	107
STR-51-DT	15,33 €	106	STR-54-DM	116,38 €	108
STR-51-DT/M	8,52 €	106	STR-54-DM/M	64,66 €	108
STR-51-DT-B	20,58 €	106	STR-54-DO	116,38 €	108
STR-51-DT-B/M	11,43 €	106	STR-54-DO/M	64,66 €	108
STR-51-DT-N	20,58 €	106	STR-54-DT	116,38 €	108
STR-51-DT-N/M	11,43 €	106	STR-54-DT/M	64,66 €	108
STR-51-N	14,49 €	106	STR-54-TPD	8,18 €	108
STR-51-N/M	8,05 €	106	STR-54-TPI	8,18 €	108
STR-51-TPT	0,88 €	106	STR-55-A	48,17 €	109
STR-51-TPT-B	1,00 €	106	STR-55-A/M	26,76 €	109
STR-51-TPT-N	1,00 €	106	STR-55-B	52,37 €	109
STR-52-30	28,51 €	107	STR-55-B/M	29,09 €	109
STR-52-30/M	15,84 €	107	STR-55-DM	61,34 €	109

Lista de precios Price list

Ref.	PVP	Pág. P.	Ref.	PVP	Pág. P.
STR-55-DM/M	34,08 €	109	STR-6-30-N/M	19,60 €	84
STR-55-DM-B	65,54 €	109	STR-6-A	20,84 €	84
STR-55-DM-B/M	36,41 €	109	STR-6-A/M	12,25 €	84
STR-55-DM-N	65,54 €	109	STR-6-B	22,05 €	84
STR-55-DM-N/M	36,41 €	109	STR-6-B/M	12,25 €	84
STR-55-DT	60,54 €	109	STR-6-CL	1,10 €	84
STR-55-DT/M	33,63 €	109	STR-6-DM	25,73 €	84
STR-55-DT-B	64,74 €	109	STR-6-DM/M	14,29 €	84
STR-55-DT-B/M	35,96 €	109	STR-6-DM-B	30,98 €	84
STR-55-DT-N	64,74 €	109	STR-6-DM-B/M	17,21 €	84
STR-55-DT-N/M	35,96 €	109	STR-6-DM-N	30,98 €	84
STR-55-GR	12,00 €	109	STR-6-DM-N/M	17,21 €	84
STR-55-N	52,37 €	109	STR-6-DO	25,73 €	84
STR-55-N/M	29,09 €	109	STR-6-DO/M	14,29 €	84
STR-55-TP	10,60 €	109	STR-6-DO-B	30,98 €	84
STR-55-TP-B	11,80 €	109	STR-6-DO-B/M	17,21 €	84
STR-55-TP-N	11,80 €	109	STR-6-DO-N	30,98 €	84
STR-56-A	27,04 €	110	STR-6-DO-N/M	17,21 €	84
STR-56-A/M	15,02 €	110	STR-6-DT	24,52 €	84
STR-56-B	32,66 €	110	STR-6-DT/M	13,62 €	84
STR-56-B/M	18,14 €	110	STR-6-DT-B	29,77 €	84
STR-56-DO	33,38 €	110	STR-6-DT-B/M	16,54 €	84
STR-56-DO/M	18,75 €	110	STR-6-DT-N	29,77 €	84
STR-56-DO-B	39,00 €	110	STR-6-DT-N/M	16,54 €	84
STR-56-DO-B/M	21,67 €	110	STR-6-N	22,05 €	84
STR-56-DO-N	39,00 €	110	STR-6-N/M	12,25 €	84
STR-56-DO-N/M	21,67 €	110	STR-6-TP	0,88 €	84
STR-56-DT	32,92 €	110	STR-6-TP-B	1,05 €	84
STR-56-DT/M	18,29 €	110	STR-6-TP-N	1,05 €	84
STR-56-DT-B	38,54 €	110	STR-7-DM	69,51 €	85
STR-56-DT-B/M	21,41 €	110	STR-7-DM/M	38,23 €	85
STR-56-DT-N	38,54 €	110	STR-7-DT	67,83 €	85
STR-56-DT-N/M	21,41 €	110	STR-7-DT/M	37,68 €	85
STR-56-GR	1,95 €	110	STR-7-TP	5,04 €	85
STR-56-N	32,66 €	110	STR-9-BASC	5,00 €	86
STR-56-N/M	18,14 €	110	STR-9-BR	16,50 €	86
STR-56-TP	10,60 €	110	STR-9-CLM	21,00 €	86
STR-56-TP-B	11,80 €	110	STR-9-DM	44,10 €	86
STR-56-TP-N	11,80 €	110	STR-9-DM/M	24,50 €	86
STR-6-30	34,07 €	84	STR-9-DM-B	49,35 €	86
STR-6-30/M	18,93 €	84	STR-9-DM-B/M	27,42 €	86
STR-6-30-B	35,28 €	84	STR-9-DM-N	49,35 €	86
STR-6-30-B/M	19,60 €	84	STR-9-DM-N/M	27,42 €	86
STR-6-30-N	35,28 €	84	STR-9-DT	42,89 €	86

Lista de precios Price list

Ref.	PVP	25 Rollos 25 Reel	50 Rollos 50 Reel	Pág. P.
STR-9-DT/M	23,83 €			86
STR-9-DT-B	49,35 €			86
STR-9-DT-B/M	27,42 €			86
STR-9-DT-N	49,35€			86
STR-9-DT-N/M	27,42€			86
STR-9-SP	9,90 €			86
STR-9-TP	1,10 €			86
STR-9-TP-B	1,30 €			86
STR-9-TP-N	1,30 €			86
STR-TS-DM	84,83 €			101
STR-TS-DM/M	47,13 €			101
STR-TS-DM-B	88,96 €			101
STR-TS-DM-B/M	48,93 €			101
STR-TS-DM-N	88,96 €			101
STR-TS-DM-N/M	48,93 €			101
STR-TS-DO	84,83 €			101
STR-TS-DO/M	47,13 €			101
STR-TS-DO-B	88,96 €			101
STR-TS-DO-B/M	48,93 €			101
STR-TS-DO-N	88,96 €			101
STR-TS-DO-N/M	48,93 €			101
STR-TS-DT	80,56 €			101
STR-TS-DT/M	44,30 €			101
STR-TS-DT-B	85,80 €			101
STR-TS-DT-B/M	47,20 €			101
STR-TS-DT-N	85,80 €			101
STR-TS-DT-N/M	47,20 €			101
STR-TS-TP	6,82 €			101
STR-TS-TP-B	8,29 €			101
STR-TS-TP-N	8,29 €			101
TES-60X60-D-MON-14.4	435,00 €			172
TES-60X60-D-MON-14.4-S	470,00 €			172
TES-60X60-D-MON-14.4-T	450,00 €			172
TES-60X60-D-TTN-14.4	435,00 €			172
TES-60X60-D-TTN-14.4-S	470,00 €			172
TES-60X60-D-TTN-14.4-T	450,00 €			172
TTN-14,4-24	124,73 €	119,58 €	109,39 €	23
TTN-14,4-24/M	27,72 €	26,57 €	24,31 €	23
TTN-19,2-24-60-24	248,40 €	238,46 €	228,96 €	24
TTN-19,2-24-60-24/M	55,20 €	52,99 €	50,88 €	24
TTN-19,2-R-A-27-55-24	273,46 €	259,85 €	246,89 €	24
TTN-19,2-R-A-27-55-24/M	60,77 €	57,74 €	54,86 €	24

Ref.	PVP	25 Rollos 25 Reel	50 Rollos 50 Reel	Pág. P.
TTN-19,2-RGBW-24	248,40 €	238,46 €	228,96 €	23
TTN-19,2-RGBW-24/M	55,20 €	52,99 €	50,88 €	23
TTN-7,2-24	78,28 €	76,01 €	69,53 €	22
TTN-7,2-24/M	17,40 €	16,89 €	15,45 €	22
WLF-12-30	2.341,81 €			63
WLF-12-30/M	122,94 €			63
WLF-12-55	2.341,81 €			63
WLF-12-55/M	122,94 €			63
WLF-12-RGB	2.559,76 €			63
WLF-12-RGB/M	134,38 €			63
WLF-CN68-D	13,18 €			64
WLF-CN68-I	13,18 €			64
WLF-CN68-RGB-D	14,63 €			64
WLF-CN68-RGB-I	14,63 €			64
WLF-PF	9,17 €			65
WLF-PF/5	1,25 €			65
WLF-TP68	6,18 €			64
WLF-TP68-RGB	8,04 €			64
WLF-UN68	26,37 €			65
WLF-UN68-RGB	27,37 €			65

Todas nuestras tiras llevan 30cm de cable en un extremo. Otras medidas de cable: a cotizar.
All our strips have 30cm of cable at one end. Other cable measures: to be quoted.



Significado de los pictogramas Meaning of the pictograms



Compatible con señal 0-10V Compatible with 0-10V signal	Tensión de alimentación 12V o 24V DC 12V o 24V DC Supply voltage				
Compatible con señal 1-10V Compatible with 1-10V signal	Tensión de alimentación 12V DC 12V DC Supply voltage				
No se puede sumergir más de 1m You can not dip more than 1m	Tensión de alimentación 24V DC 24V DC Supply voltage				
Longitud Length	Temperatura de trabajo Working temperature				
Número de Colores o CCT por Led Number of Color or CCT each Led	Apertura del haz Beam angle				
Años de garantía Years warranty	Lumens por metro Lumens per metre				
Leds por pixel Leds per pixel	Aleación del aluminio 6060 6060 aluminum alloy				
<table border="0"> <tr> <td></td> <td></td> <td></td> <td></td> </tr> </table> Watts por metro Watts per meter					Compatible con sistema Android Compatible with Android system
<table border="0"> <tr> <td></td> <td></td> <td></td> <td></td> </tr> </table>					Conexión mediante Bluetooth Connection by Bluetooth
<table border="0"> <tr> <td></td> <td></td> <td></td> <td></td> </tr> </table>					Ensayos basados en el sistema IEC Tests based on the IEC system
<table border="0"> <tr> <td></td> <td></td> </tr> </table>			Cumple los requisitos legales y técnicos de la UE Compliance legal and technical requirements of EU		
Pixels por metro Pixel per meter	Protección clase I Class I Protection				
<table border="0"> <tr> <td></td> <td></td> <td></td> <td></td> </tr> </table> Leds por metro Leds per metre					Protección clase II Class II Protection
<table border="0"> <tr> <td></td> <td></td> <td></td> </tr> </table>				Protección clase III Class III Protection	

CRI > 80	CRI > 95	Índice de reproducción cromática Color rendering index	Grado de protección contra polvo y agua Degree of protection dust and water
Cumple normativa Norte América (Canadá y EEUU) Compliance North America standards (Canada & US)	Compatible con señal KNX Compatible with KNX signal	Compatible con señal DALI Compatible with DALI signal	Archivo ldt disponible Ldt file available
Regulable Dimmable	Tipo de led Type of led	Disipador incorporado With heat sink	Linkedin
Compatible con señal DMX Compatible with DMX signal	Cumple test LM80 Test LM80 complied	Longitud disponible Length available	Fuente de alimentación con limitación de corriente Limited Power Source
Fuente de alimentación no incluida Power supply not included	Watts máximos que puede disipar por metro Watts maximum which can dissipate per metre	Componentes sensibles a la electricidad estática Electrostatically sensitive components	Instalable en muebles. Protegido térmicamente, Tc max.110 °C Installable in furniture. Thermally protected, Tc max.110 °C
Comisión Federal de Comunicaciones Federal Communications Commissions	Necesita disipador Needs heat sink	Curva fotométrica disponible Photometric graph available	Corrección del factor de potencia Power factor correction
Google+	Pinterest	Comisión Federal de Comunicaciones Federal Communications Commissions	Precio por rollo Price per reel
Grado de protección contra golpes e impactos Degree of protection against shocks & impacts	Precio por metro Price per meter	Unidad protegida a la temperatura de 110 °C Unit protected at 110 °C	Compatible con PUSH Compatible with PUSH
Instagram	Compatible con sistema iOS Compatible with iOS system		

- R9 >10

R9 >25

Valor R9 (rojos)
R9 (red) Value
- r min
12 cm

Radio mínimo al que se puede curvar
Minimum radius that can to be bent
- 

Cumple normativa australiana de compatibilidad electromagnética
Autralian mark guaranteeing compliance with electromagnetic requirements
- 

Residuos de aparatos eléctricos y electrónicos (RAEE)
Waste Electrical and Electronic Equipment (WEEE)
- 

Cumple normativa RoHS
Compliance RoHS standard
- SELV

Transformador de baja tensión de seguridad.
Low voltage transformer safety
- 

Instalable sobre superficies inflamables
Installable on flammable surfaces
- 

Corte a medida
Customized measure

A medida
- 

Instalación empotrada
Recessed installation
- 

25 mm



29,5 mm



33,3 mm



50 mm

Medida mínima del corte
Minimum dimension of cut
- 

55,5 mm



100 mm



167 mm
- 

Transformador electromagnético de seguridad
Electromagnetic safety transformer
- 

Transformador para uso independiente
Transformer for independent use
- 

Certificado por TÜV
TÜV certificate
- 

Twitter
- 

Iluminación Up&Down
Up&Down Lightning

up&down
- 

Youtube
- 

Cumple normativa EEUU
US standarts compliance
- 230V

Tensión de alimentación 230V AC
230V AC Voltage
- 

Cumple normativa UE
EU standarts compliance
- EMC

Cumple normativa de compatibilidad electromagnética
Compliance electromagnetic compatibility
- 3

Pasos
mcAdams

Pasos MacAdams
MacAdams steps

LLURIA

Asesoría de Iluminación, SLU
Francesc Layret s/n naves 1-2
08107 Martorelles - Barcelona
tel 0034 935 938 176
www.lluria.com